

TABELA DE PREÇOS TUBAGEM 2023

valsir[®]
QUALITY FOR PLUMBING

DISTRIBUTED BY



EMPRESA	5
SISTEMAS DE DRENAGEM	
PP3: sistemas de encaixe para drenagem no interior dos edifícios	9
TRIPLUS®: sistema insonorizado tricomposto para drenagem residual	21
BLACKFIRE®: sistema de encaixe para drenagem resistente ao fogo	35
SILERE®: a excelência em sistemas de drenagem silenciosos	47
PEAD: sistemas de drenagem em polietileno de alta densidade soldável	58
Acessórios	72
SISTEMA DE DRENAGEM PLUVIAL SIFÓNICO	
RAINPLUS®: sistema sifónico de drenagem pluvial	77
SIFÕES	
Gama de sifões em PP e PEAD	86
SISTEMAS DE ABASTECIMENTO	
PEXAL®: sistema multicamada para abastecimento	98
MIXAL®: sistema de multicamada de alta flexibilidade	103
PEXAL® Brass: acessórios de prensar em latão	107
BRAVOPRESS®: acessórios de prensar em tecnopolímero	117
PEXAL® EASY: acessórios de caudal total em tecnopolímero	126
Acessórios	138





EMPRESA

Valsir nasce a 1987 em Valle Sebbia, ao longo da estrada que leva ao lago de Garda. Atualmente as estratégias definidas são de uma empresa projetada para o mercado global.

Crescimento económico, desenvolvimento tecnológico, a procura da qualidade, melhoria contínua, design e presença no mercado internacional são os elementos que guiaram e ainda guiam as políticas da Valsir hoje em dia.

A necessidade de atender mercados distantes deu a origem a uma densa rede de empresas subsidiárias e associadas. A OLI - Sistemas Sanitários, S.A., nascida a 1954 e a maior produtora de autoclismos da Europa do Sul, cria uma parceria através da fusão com a Valsir em 1993 resultando em interatividades entre ambas, dentro das quais a comercialização e representatividade de tubagens e acessórios em Portugal.



Certificação qualidade Valsir



O FUTURO DOS PROJETOS

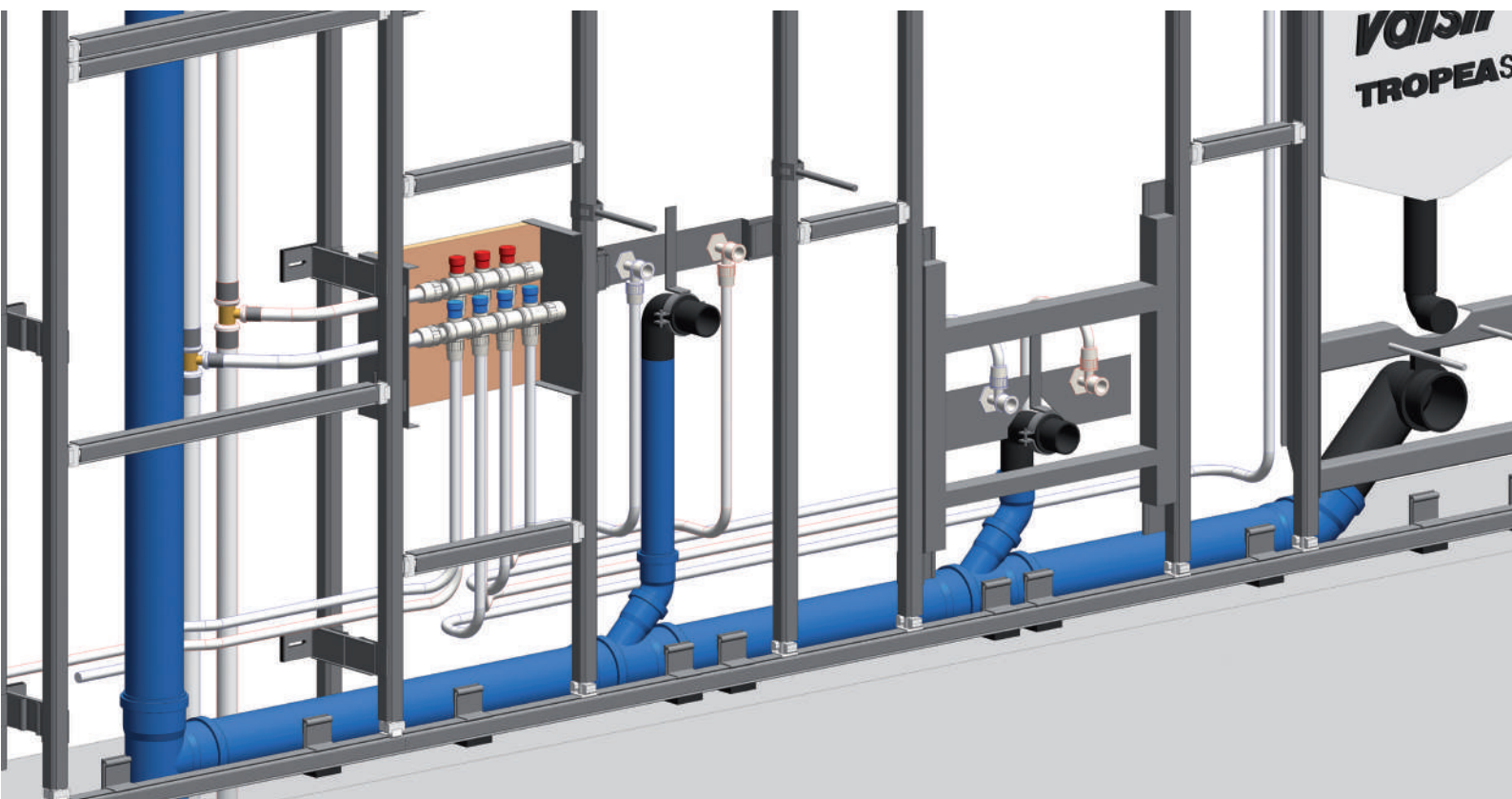

O Building Information Model é um sistema, um processo, uma filosofia de melhoria de planeamento, projeto, construção e gestão dos edifícios. A Valsir S.p.A. cria uma série de modelos a aplicações do Autodesk Revit (R) para o setor da tubagem e aquecimento.



Bimobject
awards 2016
- finalist -

Bimobject
awards 2017
- winner -

Bimobject
awards 2018
- finalist -

Descarregue o manual dos modelos Revit:
[https://www.valsir.it/en/modelli-revit/
non-categorizzato/modelli-revit](https://www.valsir.it/en/modelli-revit/non-categorizzato/modelli-revit)



PP3

Sistemas de encaixe para drenagem no interior dos edifícios



TRIPLUS®

Sistemas insonorizados tricompostos para drenagem no interior dos edifícios



BLACKFIRE®

Sistema de encaixe para drenagem resistente ao fogo



SILERE®

A excelência em sistemas de drenagem insonorizados



HDPE

Sistemas de drenagem em polietileno de alta densidade soldável



RAINPLUS®

Sistema sífónico de drenagem pluvial



SIFÕES



PEXAL®

Sistema de tubagem multicamada para abastecimento



MIXAL®

Sistema de multicamada de alta flexibilidade



PEXAL® BRASS

Acessórios de prensar em latão



BRAVOPRESS®









Acessórios de prensar em tecnopolímero



PEXAL® EASY

Acessórios de caudal total em tecnopolímero

LEGENDA

Símbolo	Unidade	Descrição
COD.	-	Código do artigo
€/un	-	Preço por unidade artigo
€/m	-	Preço por metro
D	mm	Diâmetro
DN	mm	Diâmetro nominal
	-	Perfil matriz
	n°	Quantidade por saco
	n°	Quantidade por embalagem
	n°	Quantidade por caixa
	n°	Quantidade por linha de palete
	n°	Quantidade por palete
QMM		Quantidade mínima e múltipla obrigatória por encomenda
	m	Embalagem em metros
	n°	Peças por estrutura
α	°	Graus sexagesimais
Mod.	-	Modelo
Mat.	-	Material
Dim.	-	Dimensões
Art.	-	Artigo
Conf.	-	Embalamento

Todas as dimensões no presente catálogo são em milímetros, expeto se expressamente indicado.

A OLI - Sistemas Sanitários S.A. reserva-se o direito de modificar a qualquer momento, as características dos produtos ilustrados no presente catálogo. As cores aqui representadas são indicativas.

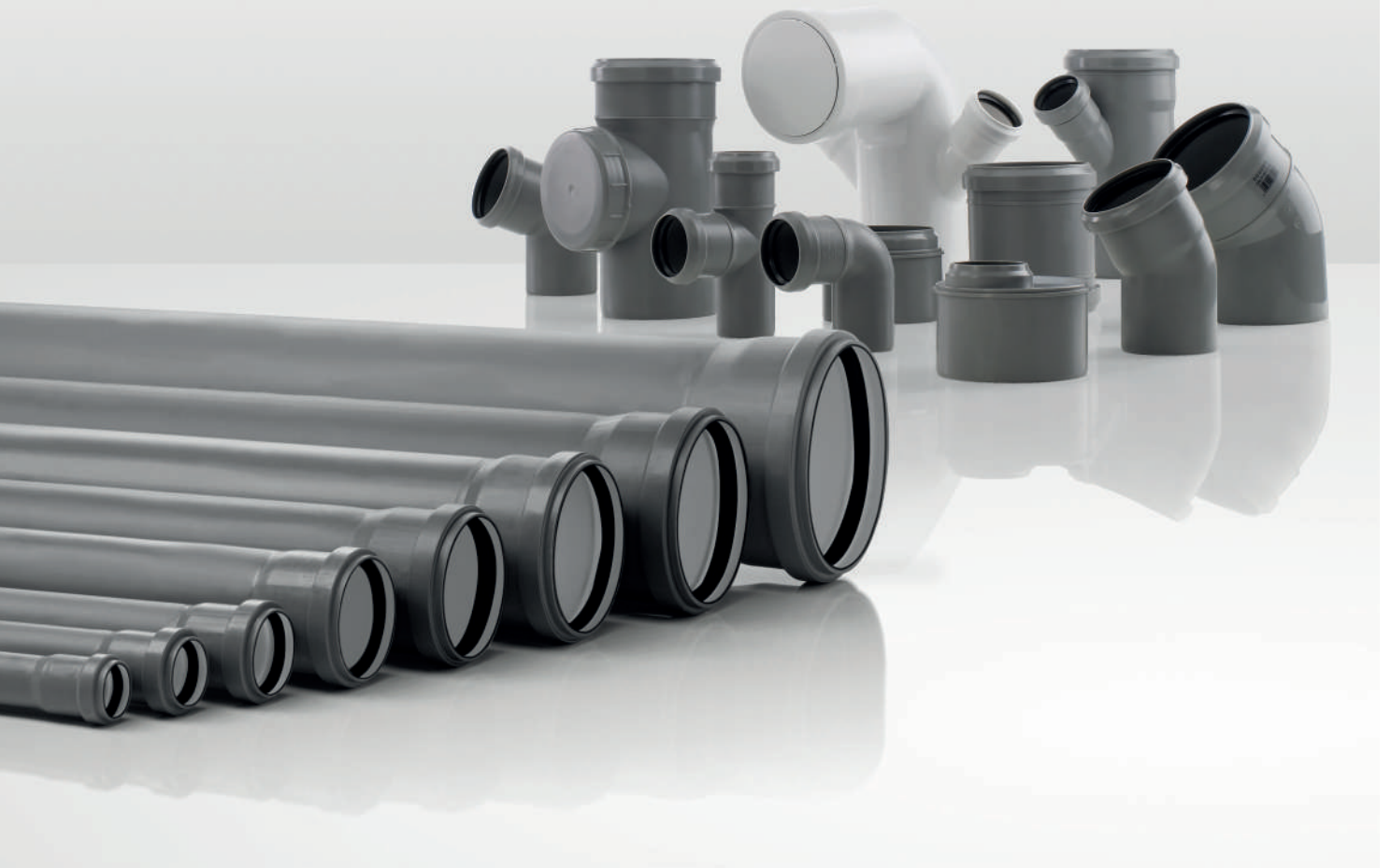

PP3: Sistemas de encaixe para drenagem no interior dos edifícios

VALSIR PP3[®], A NOVA TECNOLOGIA NOS SISTEMAS DE ENCAIXE

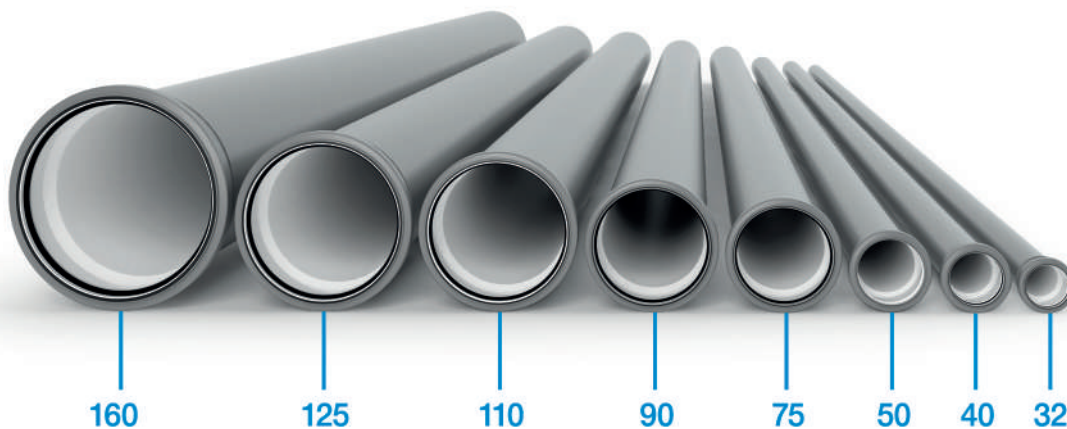

Valsir PP3[®] é o sistema de drenagem composto por tubagem e acessórios para a instalação de sistemas de drenagem residual e pluvial.

Valsir PP3[®] é um sistema extremamente leve e, graças à boca de encaixe com vedação hidráulica, representa a solução mais simples para instalações de drenagem.





Elevada resistência ao impacto a temperaturas até -10°C.



Elevada resistência química às descargas de origem doméstica e industrial.



Velocidade e extrema facilidade de instalação sem necessidade de auxílio de ferramentas, graças à conexão por encaixe.



Facilidade de conexão com outros sistemas de drenagem (ferro fundido, PVC, etc.)



A tubagem encontra-se disponível em vários comprimentos, permitindo reduzir os resíduos ao mínimo.



Baixo coeficiente de dilatação térmica.



Vasta gama de acessórios especiais que facilitam a realização de qualquer tipo de sistema.



A instalação não necessita ferramentas ou utensílios particulares.



Resistência às descargas intermitentes até temperaturas de 95°C.





O produto, a sua reciclabilidade e processos produtivos são fundados nos princípios do “Green Building”.

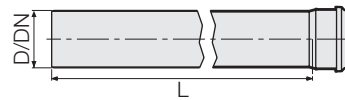

GAMA PP3

Tubo PP3 com 1
boca

COD.	D	DN	L	kg				QMM	€/un
PB10000501005	32	30	500	0,108	20	120	600	20	2.07 €
PB10000501009	32	30	1000	0,195	24	120	840	1	3.32 €
PB10000501013	32	30	2000	0,385	24	120	840	1	6.17 €
PB10000501015	32	30	3000	0,561	24	120	840	1	9.01 €
PB10000501025	40	40	500	0,129	20	120	600	20	1.60 €
PB10000501029	40	40	1000	0,245	20	100	500	1	2.57 €
PB10000501033	40	40	2000	0,482	20	100	500	1	5.21 €
PB10000501035	40	40	3000	0,682	20	100	500	1	7.58 €
PB10000501045	50	50	500	0,170	20	120	480	20	1.99 €
PB10000501049	50	50	1000	0,317	30	120	360	1	3.23 €
PB10000501053	50	50	2000	0,599	30	120	360	1	6.37 €
PB10000501055	50	50	3000	0,907	30	120	360	1	9.21 €
PB10000501065	75	70	500	0,265	20	80	240	20	2.93 €
PB10000501069	75	70	1000	0,481	20	60	180	1	5.02 €
PB10000501073	75	70	2000	0,929	20	60	180	1	13.78 €
PB10000501075	75	70	3000	1,333	20	60	180	1	12.35 €
PB10000501145	90	90	500	0,374	10	80	160	10	4.83 €
PB10000501149	90	90	1000	0,669	10	-	120	1	8.16 €
PB10000501153	90	90	2000	1,253	10	-	120	1	16.56 €
PB10000501155	90	90	3000	1,860	10	-	120	1	24.61 €
PB10000501085	110	100	500	0,549	10	60	120	1	5.54 €
PB10000501089	110	100	1000	1,024	15	30	90	1	9.29 €
PB10000501093	110	100	2000	1,930	15	30	90	1	18.99 €
PB10000501095	110	100	3000	2,833	15	30	90	1	27.78 €
PB10000501105	125	125	500	0,725	5	40	80	5	8.94 €
PB10000501109	125	125	1000	1,359	8	16	64	1	16.18 €
PB10000501113	125	125	2000	2,576	8	16	64	1	29.07 €
PB10000501115	125	125	3000	3,824	8	16	64	1	39.65 €
PB10000501125	160	150	500	1,194	1	-	37	1	17.11 €
PB10000501129	160	150	1000	2,183	6	12	36	1	27.47 €
PB10000501133	160	150	2000	4,120	6	12	36	1	49.31 €
PB10000501135	160	150	3000	6,000	6	12	36	1	68.78 €

Curva 15°

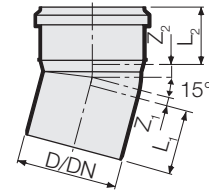

COD.	D	DN	Z ₁	L ₁	Z ₂	L ₂	kg				QMM	€/un
PB10000504001	32	30	5	48	3	45	0,021	80	640	3840	80	0.91 €
PB10000504013	40	40	6	51	8	53	0,032	50	400	1600	50	0.73 €
PB10000504025	50	50	1	51	9	50	0,040	30	240	960	30	0.82 €
PB10000504037	75	70	10	54	11	54	0,066	20	160	640	20	1.32 €
PB10000599041	90	90	8	58	12	57	0,090	20	160	480	20	1.63 €
PB10000504049	110	100	14	63	14	60	0,149	20	80	240	20	1.91 €
PB10000504061	125	125	15	69	15	72	0,226	20	80	160	20	6.32 €
PB10000504073	160	150	35	79	19	73	0,512	10	40	80	10	9.39 €

Curva 30°

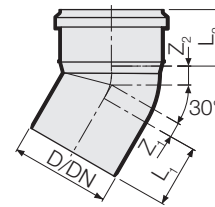

COD.	D	DN	Z ₁	L ₁	Z ₂	L ₂	kg				QMM	€/un
PB10000504003	32	30	7	48	5	45	0,021	80	640	3840	80	0.91 €
PB10000504015	40	40	9	51	11	53	0,033	50	400	1600	50	0.73 €
PB10000504027	50	50	10	52	12	51	0,041	30	240	960	30	0.82 €
PB10000504039	75	70	11	55	15	54	0,069	20	160	640	20	1.32 €
PB10000599043	90	90	14	58	17,5	57	0,098	20	80	320	20	1.63 €
PB10000504051	110	100	20	63	21	65	0,161	20	80	240	20	1.91 €
PB10000504063	125	125	24	69	23	73	0,242	20	80	160	20	6.32 €
PB10000504075	160	150	25	79	30	82	0,555	10	40	80	10	9.39 €

Curva 45°

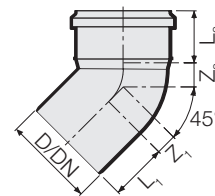

COD.	D	DN	Z ₁	L ₁	Z ₂	L ₂	kg				QMM	€/un
PB10000504005	32	30	5	53	8	45	0,022	80	640	2560	1	0.91 €
PB10000504017	40	40	9	51	14	53	0,032	50	400	1600	1	0.72 €
PB10000504029	50	50	12	52	16	51	0,040	30	240	960	1	0.82 €
PB10000504041	75	70	20	55	21	54	0,076	20	160	480	1	1.32 €
PB10000599045	90	90	22	58	25	57	0,113	20	80	240	1	1.63 €
PB10000504053	110	100	30	63	29	61	0,171	20	80	240	1	1.90 €
PB10000504065	125	125	33	69	33	72	0,260	15	60	120	1	6.32 €
PB10000504077	160	150	42	79	42	85	0,524	10	40	80	1	9.84 €

GAMA PP3

Curva 87°30'

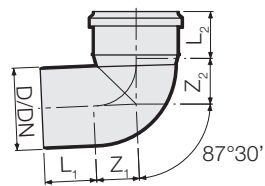

COD.	D	DN	Z ₁	L ₁	Z ₂	L ₂	kg				QMM	€/un
PB10000504011	32	30	12	53	26	45	0,024	60	480	2880	1	1.01 €
PB10000504023	40	40	23	51	26	53	0,036	50	400	1600	1	0.78 €
PB10000504035	50	50	30	52	31	57	0,051	30	240	960	1	0.86 €
PB10000504047	75	70	40	55	43	55	0,089	20	160	480	1	1.36 €
PB10000599051	90	90	48	58	51	57	0,132	20	80	240	1	1.67 €
PB10000504059	110	100	57	63	61	66	0,215	20	80	160	1	1.94 €
PB10000504071	125	125	71	69	70	72	0,321	10	40	120	1	6.77 €
PB10000504083	160	150	87	79	89	85	0,700	10	40	80	1	9.89 €

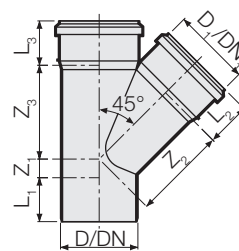

Forquilha 45°



COD.	D/D ₁	DN/DN ₁	Z ₁	Z ₂	Z ₃	L ₁	L ₂	L ₃	kg				QMM	€/un
PB10000508001	32/32	30/30	10	49	49	51	60	60	0,042	40	320	1280	40	1.63 €
PB10000508007	40/40	40/40	10	49	49	50	60	60	0,065	20	160	640	1	1.44 €
PB10000508013	50/50	50/50	12	61	61	53	55	54	0,090	20	160	640	1	2.08 €
PB10000508019	75/75	70/70	18	91	91	57	54	54	0,152	20	80	240	1	2.63 €
PB10000599061	90/90	90/90	22	110	110	58	57	57	0,227	20	80	160	1	2.85 €
PB10000508025	110/110	100/100	25	134	134	64	63	63	0,386	15	60	120	1	3.66 €
PB10000508031	125/125	125/125	28	152	152	69	68	69	0,537	10	40	80	1	43.75 €
PB10000508037	160/160	150/150	36	194	194	94	87	86	1,325	1	-	32	1	64.05 €

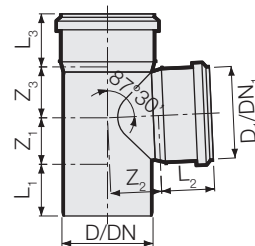

Forquilha 87°30'

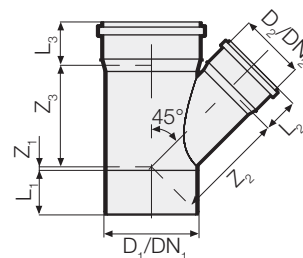

COD.	D/D ₁	DN/DN ₁	Z ₁	Z ₂	Z ₃	L ₁	L ₂	L ₃	kg				QMM	€/un
PB10000508005	32/32	30/30	23	18	25	37	50	50	0,037	40	320	1280	40	1.63 €
PB10000508011	40/40	40/40	23	25	25	64	60	59	0,064	20	160	640	20	1.45 €
PB10000508017	50/50	50/50	28	32	30	54	49	49	0,079	20	160	640	1	2.08 €
PB10000508023	75/75	70/70	40	25	43	59	54	55	0,126	20	80	240	1	2.63 €
PB10000599065	90/90	90/90	48	52	52	58	57	57	0,191	20	80	160	1	2.85 €
PB10000508029	110/110	100/100	57	60	62	62	65	65	0,321	20	80	160	1	3.71 €
PB10000508035	125/125	125/125	65	69	70	68	68	68	0,435	10	40	80	1	43.57 €
PB10000508041	160/160	150/150	83	150	89	160	87	87	1,051	4	16	32	1	64.05 €

Forquilha 45°



COD.	D/D ₁	DN/DN ₁	Z ₁	Z ₂	Z ₃	L ₁	L ₂	L ₃	kg				QMM	€/un
PB10000510001	40/32	40/30	10	45	49	41	52	46	0,050	40	320	1280	40	1.90 €
PB10000510007	50/40	50/40	5	56	54	53	57	54	0,072	20	160	640	1	1.94 €
PB10000510013	75/40	70/40	-7	73	67	55	51	59	0,105	25	100	300	1	2.53 €
PB10000510019	75/50	70/50	-1	80	74	58	54	54	0,113	25	100	300	1	2.30 €
PB10000599071	90/40	90/40	15	85	60	48	51,5	57	0,136	20	80	240	1	2.85 €
PB10000599073	90/50	90/50	-7	90,5	82	58	49,5	57	0,151	20	80	240	1	2.57 €
PB10000510025	110/40	100/40	-24	101	84	55	51	63	0,215	20	80	160	1	3.79 €
PB10000510031	110/50	100/50	-17	98	91	47	49	63	0,216	20	80	160	1	2.89 €
PB10000510037	110/75	100/70	1	120	109	63	55	65	0,273	15	60	120	1	3.20 €
PB10000510043	125/50	125/50	-24	114	99	80	54	72	0,363	10	40	120	1	11.73 €
PB10000510049	125/110	125/100	18	137	141	89	69	69	0,500	8	32	64	1	10.65 €
PB10000510061	160/110	150/100	1	171	159	99	70	82	0,932	5	20	40	1	37.44 €
PB10000510067	160/125	150/125	12	180	169	105	79	85	1,046	5	20	40	1	57.74 €

GAMA PP3

Forquilha 87°30'

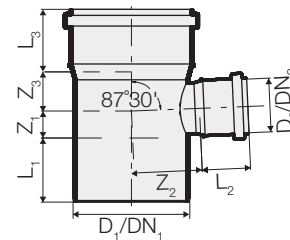

COD.	D ₁ /D ₂	DN ₁ /DN ₂	Z ₁	Z ₂	Z ₃	L ₁	L ₂	L ₃	kg				QMM	€/un
PB10000510005	40/32	40/30	23	23	25	33	51	51	0,048	40	320	1280	40	1.91 €
PB10000510011	50/40	50/40	23	30	25	54	50	50	0,065	25	200	800	25	1.94 €
PB10000510017	75/40	70/40	22	45	26	52	50	54	0,105	25	100	300	25	2.54 €
PB10000510023	75/50	70/50	27	25	31	58	50	54	0,104	25	100	300	25	2.30 €
PB10000599077	90/50	90/50	28	50	32	58	49,5	57	0,140	20	80	240	20	2.57 €
PB10000599079	90/75	90/70	39	60	44	56	54	56	0,133	20	80	240	20	2.71 €
PB10000510029	110/40	100/40	23	60	27	60	51	65	0,195	20	80	240	20	3.79 €
PB10000510035	110/50	100/50	28	62	32	60	50	64	0,210	20	80	160	20	2.89 €
PB10000510041	110/75	100/70	40	61	45	61	55	65	0,239	15	60	120	1	3.20 €
PB10000599091	110/90	100/90	40,7	62,4	51,5	62,3	57,5	60,5	0,253	10	40	120	1	17.36 €
PB10000510047	125/50	125/50	28	67	33	90	54	72	0,342	10	40	120	10	11.73 €
PB10000510053	125/110	125/100	58	70	63	83	63	68	0,402	8	32	96	1	10.65 €
PB10000510065	160/110	150/100	58	86	64	99	72	84	0,785	5	20	40	1	37.44 €
PB10000510071	160/125	150/125	64	132	71	148	79	86	0,867	5	20	40	1	57.74 €

Forquilha dupla de ângulo

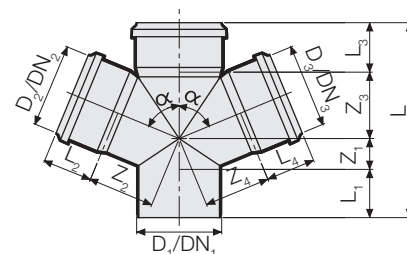
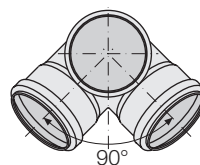

COD.	D _{1/2/3}	DN _{1/2/3}	α	Z ₁	Z ₂	Z ₃	Z ₄	L	L ₁	L ₂	L ₃	L ₄	kg				QMM	€/un
PB10000512001	110/110/110	100/100/100	67°30'	40	86	86	86	248	62	60	60	60	0,431	5	20	60	5	16.61 €
PB10000512003	110/50/110	100/50/100	67°30'	40	86	86	84	260	68	65	65	51	0,359	5	20	60	5	18.95 €
PB10000512005	110/110/50	100/100/50	67°30'	40	84	86	86	260	68	51	65	65	0,360	5	20	60	5	18.95 €
PB10000512007	110/50/50	100/50/50	67°30'	8	78	54	78	195	67	51	65	51	0,240	10	40	120	10	18.95 €
PB10000512033	110/50/110	100/50/100	87°30'	59	52,5	63,5	63,5	252	70	49,5	59,5	59,5	0,351	10	40	80	10	53.19 €
PB10000512035	110/110/50	100/100/50	87°30'	59	63,5	63,5	52,5	252	70	59,5	59,5	49,5	0,351	10	40	80	10	53.19 €

* Derivação soldada.

Forquilha tripla 87°30'

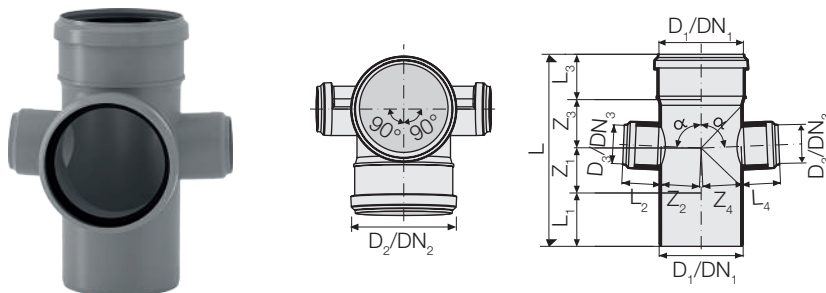

COD.	D _{1/2/3}	DN _{1/2/3}	Z ₁	Z ₂	Z ₃	Z ₁	L	L ₁	L ₂	L ₃	L ₄	kg				QMM	€/un
PB10000512037	110/110/50	100/100/50	59	52,5	63,5	52,5	252	70	49,5	59,5	49,5	0,378	10	40	80	10	53.19 €

Forquilha dupla paralela

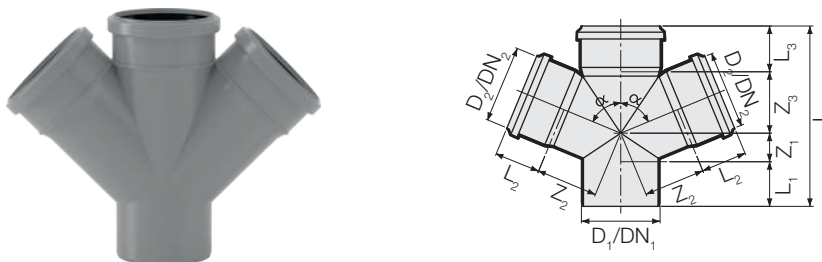

COD.	D _{1/2}	DN _{1/2}	α	Z ₁	Z ₂	Z ₃	L	L ₁	L ₂	L ₃	kg				QMM	€/un
PB10000599085	90/40	90/40	45°	15	85	85	215	58	51,5	57	0,160	15	60	180	15	9.48 €
PB10000599087	90/50	90/50	45°	7	90,5	90,5	212,5	58	49,5	57	0,174	15	60	180	15	9.48 €
PB10000506010	110/40	100/40	45°	16	104	90,5	239	72	50	60,5	0,237	10	40	120	10	26.29 €
PB10000506008	110/50	100/50	45°	16	110	91	227	62	50	58	0,245	10	40	120	10	8.57 €
PB10000506011	110/50	100/50	87°30'	28	60	32	185	60	55	65	0,271	10	40	120	10	9.93 €
PB10000506015	110/110	100/100	87°30'	57	84	86	278	70	63	65	0,395	5	20	60	5	9.46 €

Inspeção linear

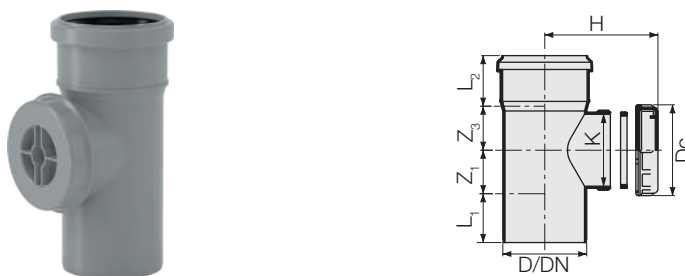

COD.	D	DN	Z ₁	Z ₃	L ₁	L ₂	K	Dc	H	kg				QMM	€/un
PB10000516003	50	50	28	30	82	54	75	90	83	0,101	20	160	640	1	4.15 €
PB10000516005	75	70	40	43	58	54	66	90	77	0,141	20	80	240	1	4.33 €
PB10000599151	90	90	49	52	58	57	100	118	85	0,243	20	80	160	1	4.97 €
PB10000516007	110	100	57	62	61	67	105	118	100	0,343	15	60	120	1	5.33 €
PB10000516009	125	125	58	63	67	69	120	149	126	0,510	10	40	80	1	13.72 €
PB10000516011	160	150	58	64	93	83	120	149	126	0,917	5	20	40	1	21.83 €

GAMA PP3

Redução concêntrica

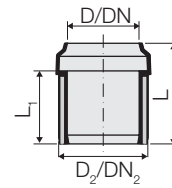

COD.	D/D ₂	DN/DN ₂	L	L ₁	kg				QMM	€/un
PB10000513000	32/40	30/40	65	50	0,021	100	800	4800	1	1.68 €
PB10000513001	40/50	40/50	56	38	0,027	80	640	3200	1	1.68 €
PB10000599135	75/90	70/90	76	61	0,060	20	160	640	1	1.81 €
PB10000599137	90/110	90/100	81,5	65	0,112	20	160	640	1	2.24 €
PB10000514015	110/125	100/125	86	68	0,131	30	120	360	1	3.71 €

Redução Excêntrica

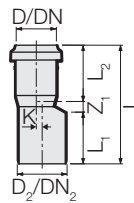

Mod. A

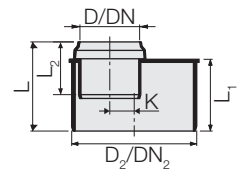

Mod. B

COD.	D/D ₂	DN/DN ₂	Mod.	K	Z ₁	L	L ₁	L ₂	kg				QMM	€/un
PB10000514001	32/40	30/40	A	4	12	98	41	44	0,023	50	400	2400	1	1.32 €
PB10000514002	32/50	30/50	A	9	15	98	38	44	0,028	40	320	1920	1	1.54 €
PB10000514003	40/50	40/50	A	5	13	125	51	58	0,036	50	400	1600	1	0.96 €
PB10000514005	40/75	40/70	B	11	54	75	60	58	0,048	30	240	960	1	1.99 €
PB10000514007	50/75	50/70	B	5	50	75	59	58	0,051	30	240	1440	1	1.13 €
PB10000514031	50/75	50/70	A	12	20	120	52	48	0,053	20	160	960	1	1.13 €
PB10000599131	40/90	40/90	B	7	-	77	61	46,5	0,066	20	160	640	1	1.45 €
PB10000599133	50/90	50/90	B	11	-	76	61	45,5	0,066	20	160	640	1	1.27 €
PB10000514033	50/90	50/90	A	19,5	28	132	55	49	0,070	20	160	640	1	1.27 €
PB10000514035	75/90	70/90	A	7	13	122	55	54	0,075	20	160	640	1	1.45 €
PB10000514008	40/110	40/100	B	21,5	-	83	66	47	0,093	20	160	640	1	3.64 €
PB10000514009	50/110	50/100	B	9	50	82	66	54	0,096	20	160	640	1	1.45 €
PB10000514037	50/110	50/100	A	30	36	143	59	48	0,105	20	160	480	1	1.45 €
PB10000514011	75/110	70/100	B	16	55	82	66	56	0,101	20	160	640	1	1.58 €
PB10000514039	75/110	70/100	A	17	27	139	59	53	0,109	20	160	480	1	1.58 €
PB10000514041	90/110	90/100	A	9,5	23	139	59	57	0,121	20	160	480	1	1.68 €
PB10000514013	75/125	70/125	B	0	55	85	70	55	0,134	20	160	480	1	3.35 €
PB10000514043	110/125	100/125	A	7	12	138	64	62	0,165	20	80	240	1	3.16 €
PB10000514017	110/160	100/150	B	10	80	173	97	81	0,317	20	80	240	1	8.57 €
PB10000514019	125/160	125/150	B	4	80	160	92	82	0,296	20	80	240	1	9.03 €

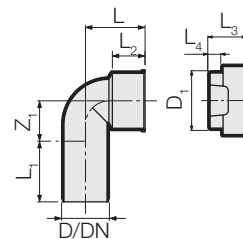
**Curva técnica, com
tampão, sem o-ring**

COD.	D/D ₁	DN	Z ₁	L	L ₁	L ₂	L ₃	L ₄	kg				QMM	€/un
PB10000518103	32/46	30	23	50	51	27	30	10	0,040	40	320	1280	40	1.24 €
PB10000518107	40/46	40	23	50	51	30	30	10	0,040	40	320	1280	40	1.24 €
PB10000518113	40/53,5	40	30	50	55	27	30	10	0,049	20	160	960	20	1.42 €
PB10000518117	50/53,5	50	30	52	55	28	30	10	0,051	20	160	960	20	1.57 €
PB10000518121	50/60	50	33	58	60	28	30	10	0,054	20	160	960	20	1.63 €

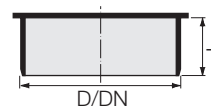
Tampão de fecho

COD.	D	DN	L	kg				QMM	€/un
PB10000524001*	40	40	32	0,011	40	800	5600	1	0.60 €
PB10000524003	50	50	32	0,014	20	400	2800	1	0.78 €
PB10000524005	75	70	32	0,024	15	300	2100	1	0.96 €
PB10000599141	90	90	35	0,033	30	240	1440	1	1.01 €
PB10000524007	110	100	40	0,068	20	160	960	1	1.09 €
PB10000524009	125	125	47	0,100	10	80	480	1	2.89 €
PB10000524011	160	150	48	0,135	10	80	320	1	5.33 €

* Tampão de cor azul

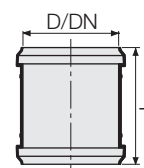

União deslizante

COD.	D	DN	L	kg				QMM	€/un
PB10000526000	32	30	85	0,023	60	480	2880	1	1.32 €
PB10000526001	40	40	108	0,037	30	240	1440	1	1.04 €
PB10000526003	50	50	108	0,049	30	240	1440	1	1.09 €
PB10000526005	75	70	120	0,076	20	160	640	1	1.76 €
PB10000599101	90	90	120	0,101	20	160	480	1	1.99 €
PB10000526007	110	100	136	0,170	20	80	240	1	2.17 €
PB10000526009	125	125	147	0,232	20	80	160	1	7.41 €
PB10000526011	160	150	204	0,554	10	40	80	1	12.45 €

GAMA PP3

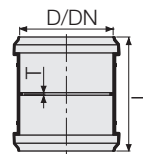

União dupla

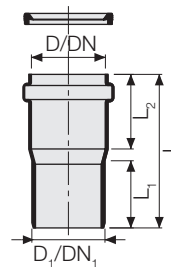

COD.	D	DN	L	T	kg				QMM	€/un
PB10000528000	32	30	85	2	0,024	60	480	2880	1	1.32 €
PB10000528001	40	40	108	2	0,037	30	240	1440	1	1.04 €
PB10000528003	50	50	108	2	0,050	30	240	1440	1	1.09 €
PB10000528005	75	70	120	2	0,077	20	160	640	1	1.76 €
PB10000599111	90	90	120	2	0,101	20	160	480	1	1.99 €
PB10000528007	110	100	136	3	0,172	20	80	240	1	2.17 €
PB10000528009	125	125	147	3	0,235	20	80	160	1	7.41 €
PB10000528011	160	150	210	28	0,558	10	40	80	1	12.45 €

Adaptador para
ligação a PVC



COD.	D/DN	D ₁ /DN ₁	L	L ₁	L ₂	kg				QMM	€/un
PC10000564121	40/40	40/40	105	50	55	0,045	40	320	1920	40	3.60 €
PC10000564122	50/43	50/40	105	44	47	0,051	30	240	1440	30	3.96 €
PC10000564123	50/50	50/50	105	50	55	0,054	30	240	1440	30	3.70 €
PC10000564150	50/50	100/100	130	91	40	0,186	10	80	480	10	12.70 €
PC10000564075	75/70	75/70	144	87	58	0,177	15	120	480	15	7.74 €
PC10000564131	75/70	80/80	154	78	75	0,176	15	120	480	15	7.74 €
PC10000564182	75/70	82/80	159	78	80	0,197	15	120	480	15	7.74 €
PC10000564175	75/70	100/100	156	77	77	0,143	10	80	480	10	9.27 €
PC10000564190	90/90	100/100	143	76	65	0,216	10	80	320	10	8.59 €
PC10000564101	110/100	100/100	147	83	57	0,241	10	80	320	10	11.96 €
PC10000564251	110/100	125/125	145	83	60	0,290	10	80	240	10	9.02 €

TRIPLUS

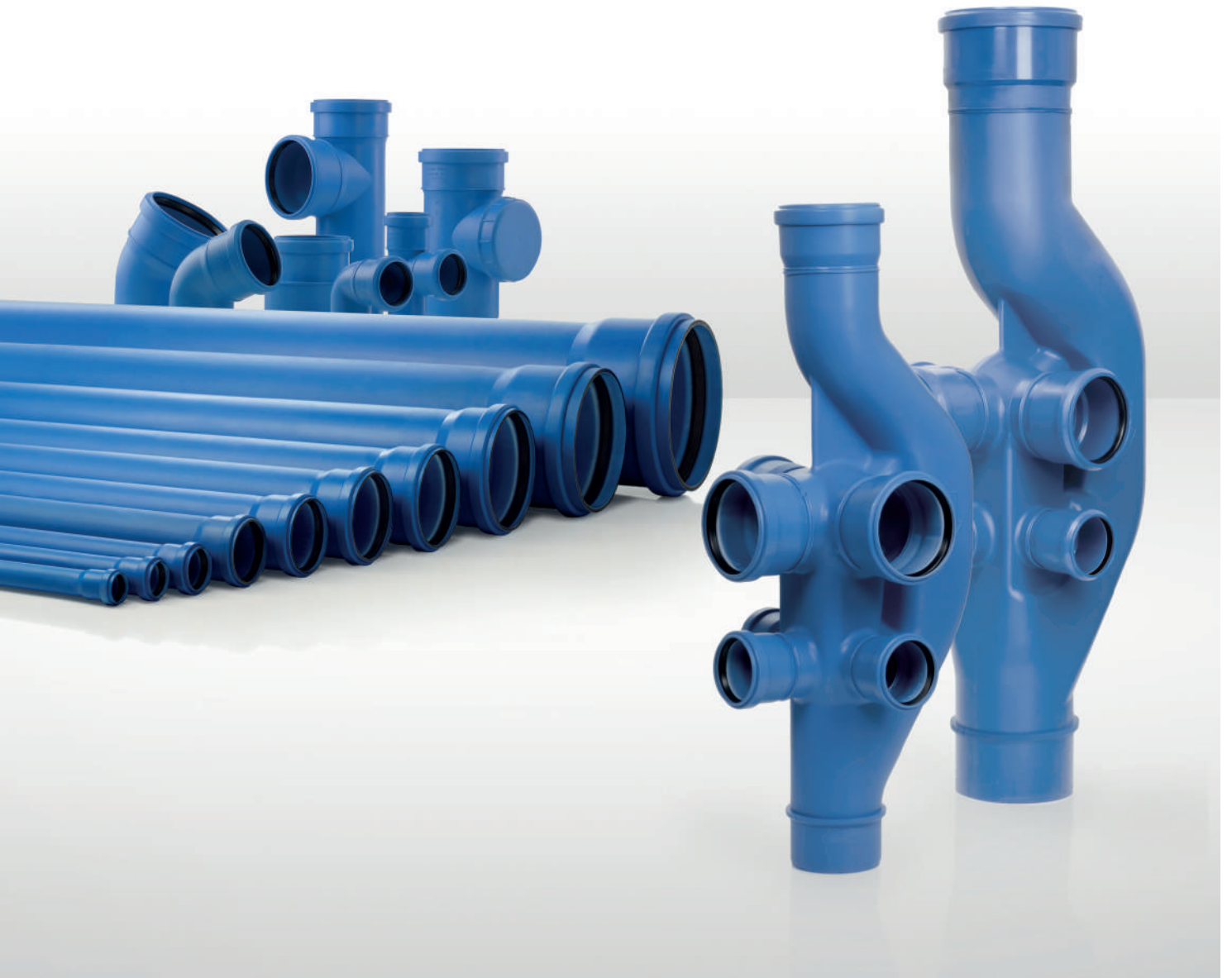

**TRIPLUS®: sistema insonorizado
tricomposto para drenagem residual**

TRIPLUS®, A EVOLUÇÃO DO SISTEMA DE DRENAGEM POR ENCAIXE

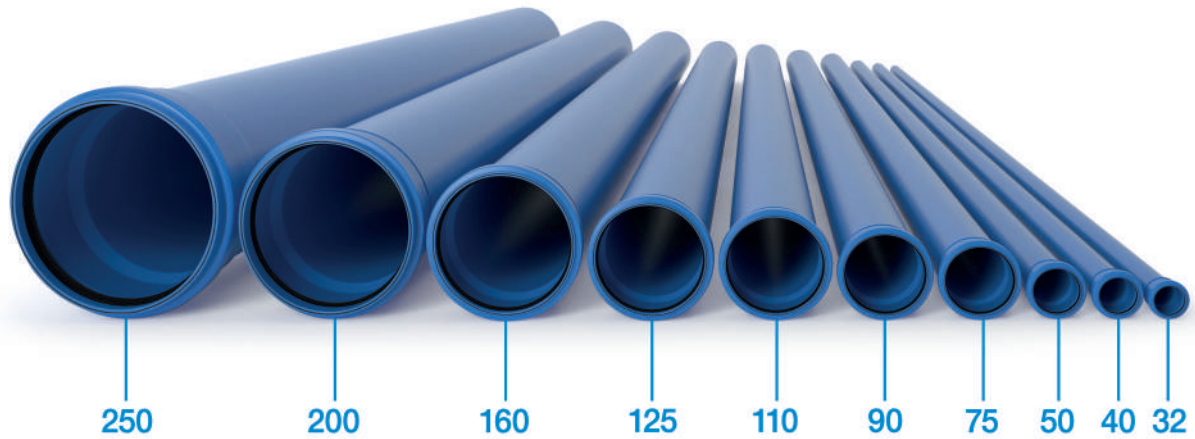

A tubagem Triplus é constituída por três camadas de material que garantem características mecânicas extremamente elevadas mesmo a baixas temperaturas e ótimas prestações acústicas.





Material caracterizado de uma elevada resistência ao impacto a baixa temperatura (até -25°C).



Resistência às descargas intermitentes até temperaturas de 95°C.



Ótimas performances fono-isolantes do sistema. Para uma caudal de 2 l/s os níveis de ruído segundo a EN 14366 são de 12 DB(A).



Elevada resistência química às descargas de origem doméstica e industrial.



Velocidade e extrema facilidade de instalação sem necessidade de auxílio de ferramentas, graças à conexão por encaixe.



Facilidade de conexão com outros sistemas de drenagem (ferro fundido, PVC, etc.)



Baixo coeficiente de dilatação térmica.



Os tubos estão disponíveis em vários comprimentos permitindo assim reduzir ao mínimo o desperdício.





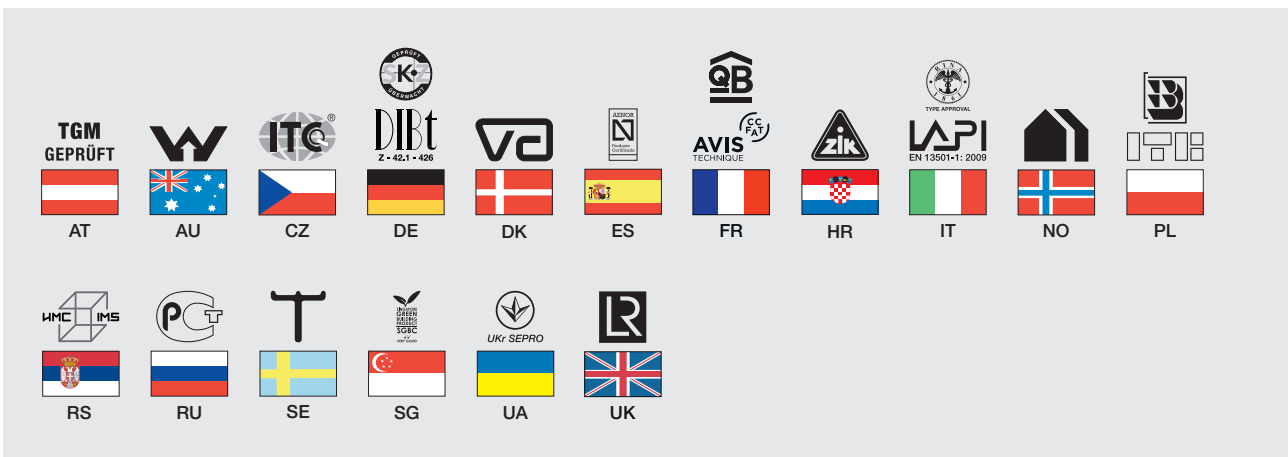

O produto, a sua reciclabilidade e processos produtivos são fundados nos princípios do "Green Building".

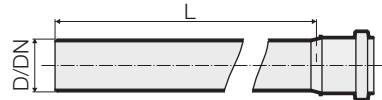

GAMA TRIPLUS

HTEM tubo 1 boca



COD.	D	DN	L	kg				QMM	€/un
PB30000650005	32	30	500	0,126	30	180	900	30	2.99 €
PB30000650007	32	30	1000	0,238	24	120	840	1	4.69 €
PB30000650011	32	30	2000	0,441	24	120	840	1	8.70 €
PB30000650013	32	30	3000	0,655	24	120	840	1	13.16 €
PB30000650025	40	40	500	0,160	50	200	600	50	2.99 €
PB30000650027	40	40	1000	0,311	20	100	500	1	4.69 €
PB30000650031	40	40	2000	0,594	20	100	500	1	8.70 €
PB30000650033	40	40	3000	0,895	20	100	500	1	14.05 €
PB30000650045	50	50	500	0,213	35	140	420	35	3.24 €
PB30000650047	50	50	1000	0,386	30	120	360	1	4.70 €
PB30000650051	50	50	2000	0,779	30	120	360	1	9.67 €
PB30000650053	50	50	3000	1,137	30	120	360	1	15.13 €
PB30000650065	75	70	500	0,471	20	80	240	20	5.48 €
PB30000650067	75	70	1000	0,899	20	60	180	1	7.88 €
PB30000650071	75	70	2000	1,723	20	60	180	1	14.76 €
PB30000650073	75	70	3000	2,400	20	60	180	1	21.91 €
PB30000650085	90	90	500	0,698	24	96	192	24	7.36 €
PB30000650087	90	90	1000	1,317	10	-	120	1	11.60 €
PB30000650091	90	90	2000	2,545	10	-	120	1	21.99 €
PB30000650093	90	90	3000	3,060	10	-	120	1	31.86 €
PB30000650105	110	100	500	0,966	15	60	120	15	8.24 €
PB30000650107	110	100	1000	1,866	15	30	90	1	12.90 €
PB30000650111	110	100	2000	3,346	15	30	90	1	24.38 €
PB30000650113	110	100	3000	5,162	15	30	90	1	35.35 €
PB30000650125	125	125	500	1,272	6	48	96	6	11.58 €
PB30000650127	125	125	1000	2,330	8	16	64	1	18.75 €
PB30000650131	125	125	2000	4,432	8	16	64	1	34.61 €
PB30000650133	125	125	3000	6,545	8	16	64	1	48.95 €
PB30000650145	160	150	500	2,101	1	-	36	1	18.03 €
PB30000650147	160	150	1000	3,920	6	12	36	1	28.57 €
PB30000650151	160	150	2000	7,404	6	12	36	1	53.11 €
PB30000650153	160	150	3000	10,700	6	12	36	1	76.20 €
PB30000650167	200	200	1000	6,268	4	-	-	1	67.70 €
PB30000650171	200	200	2000	11,568	4	-	-	1	119.93 €
PB30000650173	200	200	3000	16,765	4	-	-	1	169.05 €
PB30000650187	250	250	1000	9,805	4	-	-	1	114.12 €
PB30000650193	250	250	3000	27,300	4	-	-	1	284.44 €

HTB curva 45°

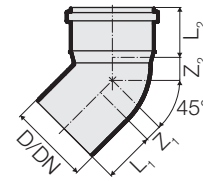

COD.	D	DN	Z ₁	L ₁	Z ₂	L ₂	kg				QMM	€/un
PB30000650405	32	30	8	45	10	44	0,022	80	640	3200	1	1.61 €
PB30000650415	40	40	10	47	14	44	0,048	50	400	2000	1	1.61 €
PB30000650425	50	50	11	48	17	46	0,062	30	240	1200	1	2.03 €
PB30000650435	75	70	18	53	22	52	0,145	20	160	480	1	3.48 €
PB30000650445	90	90	21	56	26	56	0,221	20	80	320	1	4.74 €
PB30000650455	110	100	25	61	31	59	0,339	20	80	240	1	4.97 €
PB30000650465	125	125	28	66	35	64	0,500	15	60	120	1	9.95 €
PB30000650475	160	150	-	82	41	77	0,955	1	-	80	1	15.53 €
PB30000650485	200	200	42	115	57	114	1,946	1	-	35	1	95.95 €
PB30000650495	250	250	52	155	86	138	3,995	1	-	14	1	172.96 €

HTB curva 87°30'

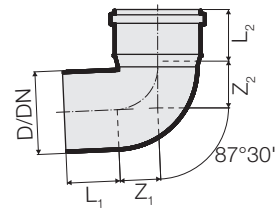

COD.	D	DN	Z ₁	L ₁	Z ₂	L ₂	kg				QMM	€/un
PB30000650409	32	30	20	45	19	44	0,024	60	480	3360	1	1.70 €
PB30000650419	40	40	22	47	25	44	0,054	50	400	2000	1	1.70 €
PB30000650429	50	50	26	48	30	46	0,072	30	240	1200	1	2.24 €
PB30000650439	75	70	40	53	43	52	0,177	20	160	480	1	4.55 €
PB30000650449	90	90	46	56	51	56	0,277	20	80	320	1	5.05 €
PB30000650459	110	100	57	61	61	59	0,420	20	80	160	1	5.32 €
PB30000650469	125	125	62	66	70	64	0,608	10	40	120	1	14.57 €
PB30000650479	160	150	-	82	85	77	1,119	1	-	65	1	24.08 €
PB30000650489	200	200	96	115	110	115	2,435	1	-	30	1	111.95 €
PB30000650499	250	250	120	155	140	152	4,812	1	-	14	1	190.73 €

GAMA TRIPLUS

HTEA forquilha 45°

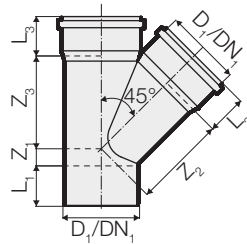

COD.	D ₁	DN ₁	Z ₁	L ₁	Z ₂	L ₂	Z ₃	L ₃	kg				QMM	€/un
PB30000650501	32	32	7	50	44	44	44	44	0,041	40	320	1600	40	3.48 €
PB30000650507	40	40	10	46	49	44	49	44	0,090	20	160	1120	1	3.73 €
PB30000650513	50	50	12	50	61	46	61	46	0,119	20	160	640	1	4.44 €
PB30000650519	75	70	19	53	96	52	96	52	0,306	20	80	240	1	6.13 €
PB30000650525	90	90	21	56	110	56	110	56	0,482	20	80	160	1	9.26 €
PB30000650531	110	100	25	61	135	59	135	59	0,727	10	40	80	1	10.36 €
PB30000650537	125	125	28	66	152	65	152	65	1,070	5	20	60	1	35.89 €
PB30000650543	160	150	-	82	194	77	195	77	2,024	1	-	32	1	55.98 €
PB30000650669 *	200	200	-	150	318	135	318	135	5,305	1	-	12	1	165.85 €
PB30000650685 *	250	250	52	180	333	163	333	162	9,511	1	-	7	1	290.23 €

* Peça soldada.

HTEA forquilha
87°30'

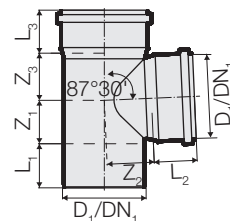

COD.	D ₁	DN ₁	Z ₁	L ₁	Z ₂	L ₂	Z ₃	L ₃	kg				QMM	€/un
PB30000650505	32	32	21	45	17	52	17	52	0,037	40	320	1600	40	3.48 €
PB30000650511	40	40	19	46	24	44	28	44	0,082	20	160	1120	20	3.73 €
PB30000650517	50	50	28	50	29	46	29	46	0,109	20	160	800	1	4.44 €
PB30000650523	75	70	39	53	46	52	46	52	0,258	20	80	240	1	6.13 €
PB30000650529	90	90	48	56	52	56	52	56	0,402	20	80	160	1	9.26 €
PB30000650535	110	100	56	61	65	59	65	59	0,595	10	40	120	1	10.36 €
PB30000650541	125	125	65	66	71	65	71	65	0,848	10	40	80	1	35.89 €
PB30000650547	160	150	-	82	89	78	93	77	1,582	1	-	40	1	55.98 €
PB30000650671 *	200	200	95	150	134	136	134	136	4,318	1	-	15	1	176.50 €
PB30000650687 *	250	250	130	170	165	160	165	160	7,842	1	-	6	1	293.79 €

* Peça soldada.

Forquilha curva 87°30'

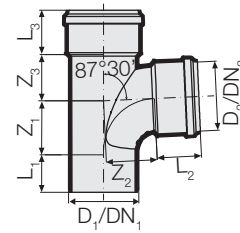

COD.	D ₁ /D ₂	DN ₁ /DN ₂	Z ₁	L ₁	Z ₂	L ₂	Z ₃	L ₃	kg				QMM	€/un
PB30000650694	90/90	90/90	57	56	64	56	47	59	0,415	20	80	160	1	10.77 €
PB30000650695	110/75	100/70	48	81	54	52	58	59	0,503	10	60	120	1	10.77 €
PB30000650696	110/90	100/90	57	72	64	56	58	59	0,539	10	40	120	1	11.23 €
PB30000650693	110/110	100/100	69	64	78	66	58	59	0,648	8	32	96	1	19.09 €

HTEA forquilha de redução 45°

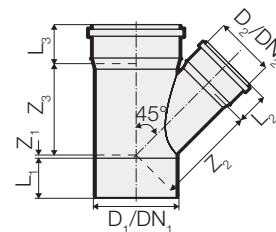

COD.	D ₁ /D ₂	DN ₁ /DN ₂	Z ₁	L ₁	Z ₂	L ₂	Z ₃	L ₃	kg				QMM	€/un
PB30000650551	40/32	40/30	5	52	45	47	42	52	0,051	40	320	1280	40	3.73 €
PB30000650557	50/40	50/40	5	50	56	44	54	46	0,106	20	160	800	1	4.44 €
PB30000650563	75/40	70/40	-7	46	79	44	71	52	0,206	25	100	300	1	6.13 €
PB30000650569	75/50	70/50	-1	54	84	46	76	54	0,220	25	100	300	1	6.13 €
PB30000650575	90/40	90/40	-10	56	87	44	76	56	0,287	20	80	240	1	9.26 €
PB30000650581	90/50	90/50	-9	56	90	46	83	56	0,296	20	80	240	1	9.26 €
PB30000650587	110/40	100/40	-24	61	99	44	89	59	0,378	20	80	160	1	10.36 €
PB30000650593	110/50	100/50	-17	61	106	46	79	59	0,414	20	80	160	1	10.36 €
PB30000650599	110/75	100/70	1	61	121	52	112	59	0,526	15	60	120	1	10.36 €
PB30000650689 ♦	110/90	100/90	25	61	162	60	135	59	0,843	10	40	80	1	11.68 €
PB30000650605	125/50	125/50	-24	66	114	46	111	65	0,575	10	40	120	1	23.65 €
PB30000650611	125/110	125/100	18	66	146	59	142	65	0,928	8	32	64	1	23.65 €
PB30000650617	160/110	150/100	-	82	-	-	167	77	1,399	1	-	40	1	37.27 €
PB30000650623	160/125	150/125	-	82	-	-	170	77	1,555	1	-	40	1	37.27 €
PB30000650629 *	200/110	200/100	-20	150	227	64	205	136	2,963	1	-	20	1	112.54 €
PB30000650633 *	200/125	200/125	-13	151	236	75	219	134	3,124	1	-	20	1	116.10 €
PB30000650637 *	200/160	200/160	14	150	257	75	244	134	3,709	1	-	18	1	119.65 €
PB30000650643 *	250/110	250/100	-47	180	262	64	235	162	5,514	1	-	10	1	157.55 €
PB30000650647 *	250/160	250/150	-12	180	308	78	251	162	6,629	1	-	10	1	175.32 €
PB30000650650 *	250/200	250/200	16	180	307	135	300	162	7,396	1	-	8	1	240.47 €

* Peça soldada.

♦ Forquilha simples com redução inserida na derivação.

GAMA TRIPLUS

HTEA forquilha de
redução 87°30'

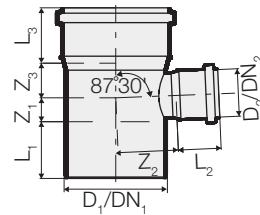

COD.	D ₁ /D ₂	DN ₁ /DN ₂	Z ₁	L ₁	Z ₂	L ₂	Z ₃	L ₃	kg				QMM	€/un
PB30000650555	40/32	40/30	18	52	23	50	20	50	0,048	40	320	1280	40	3.73 €
PB30000650561	50/40	50/40	23	50	29	44	24	46	0,099	25	200	800	25	4.44 €
PB30000650567	75/40	70/40	22	53	47	44	30	52	0,191	25	100	300	25	6.13 €
PB30000650573	75/50	70/50	27	53	46	46	35	52	0,204	25	100	300	25	6.13 €
PB30000650579	90/40	90/40	23	56	50	44	29	56	0,266	15	60	240	15	9.26 €
PB30000650585	90/50	90/50	24	56	50	46	34	56	0,275	20	80	240	1	9.26 €
PB30000650591	110/40	100/40	21	61	62	44	32	59	0,359	20	80	240	20	10.36 €
PB30000650597	110/50	100/50	26	61	64	46	37	59	0,384	20	80	240	1	10.36 €
PB30000650603	110/75	100/70	38	61	67	52	49	59	0,453	15	60	120	1	10.36 €
PB30000650691 ♦	110/90	100/90	56	61	90	60	65	59	0,705	10	40	120	1	11.68 €
PB30000650609	125/50	125/50	28	66	68	46	36	65	0,525	10	40	120	1	23.65 €
PB30000650615	125/110	125/100	58	66	72	59	64	65	0,751	8	32	96	1	23.65 €
PB30000650621	160/110	150/100	-	82	-	-	67	77	1,177	1	-	65	1	37.27 €
PB30000650627	160/125	150/125	-	82	-	-	75	77	1,427	1	-	65	1	37.27 €
PB30000650631 *	200/110	200/100	50	150	134	64	101	134	2,873	1	-	20	1	120.81 €
PB30000650635 *	200/125	200/125	57	150	135	75	99	134	2,764	1	-	18	1	125.58 €
PB30000650639 *	200/160	200/150	118	150	138	76	116	134	3,205	1	-	20	1	130.31 €
PB30000650645 *	250/110	250/100	70	180	145	64	77	162	4,632	1	-	10	1	181.24 €
PB30000650649 *	250/160	250/150	74	180	174	78	118	162	6,091	1	-	10	1	199.02 €
PB30000650651 *	250/200	250/200	95	180	160	135	138	162	6,764	1	-	8	1	260.61 €

* Peça soldada.

♦ Forquilha simples com redução inserida na derivação.

HTDA forquilha dupla
45°

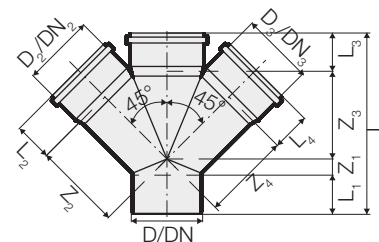

COD.	D _{1/2/3}	DN _{1/2/3}	L	Z ₁	L ₁	Z _{2/3/4}	L _{2/3/4}	kg				QMM	€/un
PB30000650655	110/110/110	100/100/100	280	25	61	136	59	0,921	5	20	60	5	20.71 €

HTDA forquilha dupla 87°30'

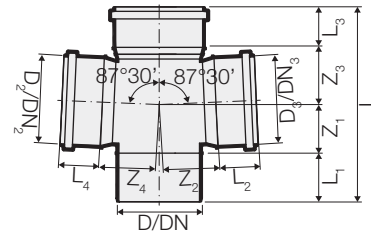

COD.	D _{1/2/3}	DN _{1/2/3}	L	Z ₁	L ₁	Z _{2/4}	L _{2/4}	Z ₃	L ₃	kg				QMM	€/un
PB30000650654	110/50/50	100/50/50	181,5	25	60	63	44	42,5	54	0,399	5	40	120	5	41.39 €
PB30000650656	110/110/110	100/100/100	249	64	60	72	52	73	52	0,728	5	20	60	5	41.39 €
PB30000650659 *	125/110/110	125/100/100	252	59	65	79	52	72	56	0,897	5	20	60	5	90.55 €
PB30000650667 *	160/110/110	150/100/100	289	61	84	100	52	81	63	1,295	1	-	45	1	161.64 €

* Peça soldada.

Forquilha curva dupla 87°30'

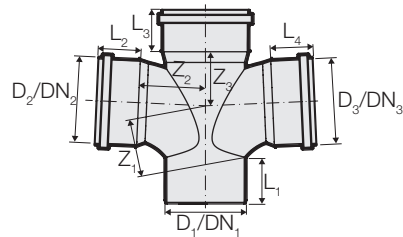

COD.	D _{1/2/3}	DN _{1/2/3}	Z ₁	L ₁	Z ₂	L ₂	Z ₃	L ₃	L ₄	kg				QMM	€/un
PB30000652910	90/90/75	90/90/70	57	56	64	56	47	56	53	0,531	15	60	120	15	34.55 €
PB30000652911	90/90/90	90/90/90	57	56	64	56	47	56	56	0,531	12	48	96	12	34.55 €
PB30000652912	110/110/75	100/100/70	69	64	78	66	58	59	52	0,649	5	30	60	5	38.39 €
PB30000652913	110/110/90	100/100/90	69	64	78	66	58	59	56	0,684	5	30	60	5	39.79 €
PB30000652914	110/110/110	100/100/100	69	64	78	66	58	59	59	0,722	5	-	60	5	41.39 €

HTED forquilha de ângulo 87°30'

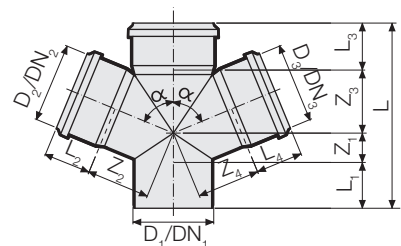
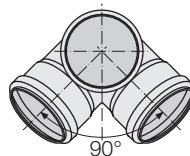

COD.	D _{1/2/3}	DN _{1/2/3}	Z ₁	Z _{2/4}	Z ₃	L	L ₁	L _{2/4}	L ₃	kg				QMM	€/un
PB30000650657	110/110/110	100/100/100	54	77	71	242	63	54	54	0,738	5	20	60	5	43.33 €
PB30000650661	125/110/110	125/100/100	54	77	71	255	71	54	59	0,931	5	20	60	5	50.62 €
PB30000650662 *	160/110/110	150/100/100	68	100	77	290	78	52	67	1,297	1	-	50	1	161.64 €

* Derivação soldada.

GAMA TRIPLUS

Triplus Multiforquilha

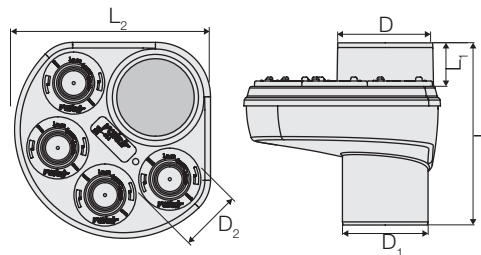

COD.	D	D ₁	D ₂	L	L ₁	L ₂	kg				QMM	€/un
PB30000652001	110	110	4x32-50	230	55	250	1,342	2	16	48	2	76.78 €

Peça soldada.

VBF
Forquilha
misturadora

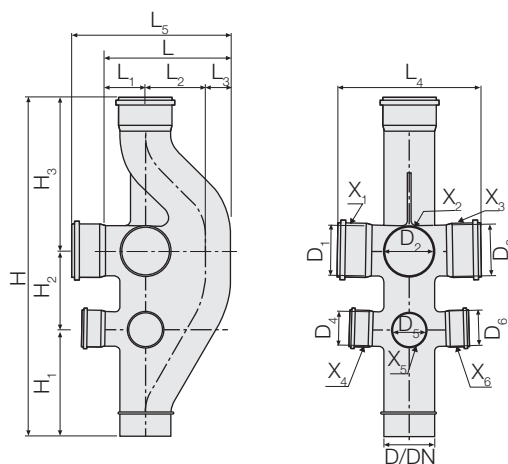

COD.	D	DN	D _{1/2/3}	D _{4/5/6}	L	L ₁	L ₂	L ₃	L ₄	L ₅	H	H ₁	H ₂	H ₃	€/un
PB30000651X ₁ X ₂ X ₃ X ₄ X ₅ X ₆ *	110	100	110	75	265	85	130	50	300	345	780	245	172	365	**
PB30000654X ₁ X ₂ X ₃ X ₄ X ₅ X ₆ *	160	150	110	75	300	100	145	55	340	380	880	310	163	400	**

* O "X" assume o valor de 0 a entrada não for necessária, caso contrário assume o valor de 1 e é soldado um encaixe. Está previsto um lote mínimo por encomenda.

** Sob encomenda.

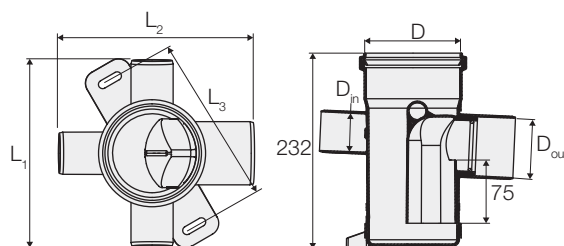

T-TRAP
Ralo em Triplus,
sifonado e
inspecionável,
ligações verticais e
horizontais





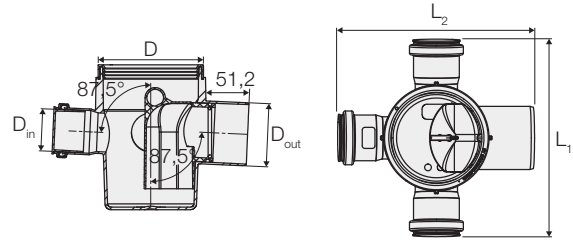

COD.	D	D _{in}	D _{out}	L ₁	L ₂	L ₃	kg				QMM	€/un
PB50000701741	110	3x50	1x75	220	230	200	0,615	5	20	60	5	33.42 €

Ralo sifonado em Triplus constituído por uma entrada superior de diâmetro 110 mm com boca e o-ring, 3 entradas laterais diâmetro 50 mm, 1 saída lateral diâmetro 75 mm. O ralo é dotado de um fecho hídrico de 75 mm. é fornecido com suporte inferior completo para montagem no teto.

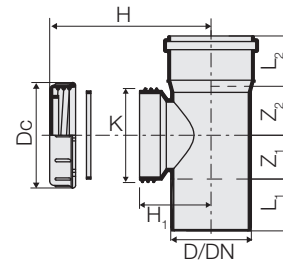
**Ralo em Triplus
H 170 , sifonado
e inspecionável,
ligações verticais e
horizontais**





COD.	D	D _{in}	D _{out}	L ₁	L ₂	kg				QMM	€/un
PB50000701743	110	3x50	1x75	232	232	0,496	5	20	60	5	26.61 €

**HTRE forquilha de
inspeção com tampa
roscada**

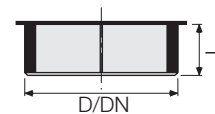
COD.	D	DN	Z ₁	L ₁	Z ₂	L ₂	H	Dc	K	H ₁	kg				QMM	€/un
PB30000650901	50	50	36	48	35	46	65	90	74	57	0,185	20	160	640	1	7.94 €
PB30000650903	75	70	40	53	43	52	85	90	74	66	0,258	20	80	240	1	9.72 €
PB30000650905	90	90	49	58	55	56	90	120	105	80	0,485	20	80	160	1	12.87 €
PB30000650907	110	100	55	61	65	59	100	120	105	90	0,605	15	60	120	1	15.12 €
PB30000650909	125	125	65	66	71	65	105	150	128	98	0,941	10	40	80	1	29.57 €
PB30000650911	160	150	64	75	75	73	125	150	128	118	1,408	1	-	62	1	45.52 €
PB30000650913 *	200	200	76	145	110	135	150	150	128	142	2,919	1	-	22	1	187.11 €
PB30000650915 *	250	250	81	170	113	160	165	150	128	158	4,817	1	-	15	1	231.77 €

* Peça soldada.

**HTM tampão de
fecho**

COD.	D	DN	L	kg				QMM	€/un
PB30000650951	40	40	32	0,011	40	800	5600	40	1.70 €
PB30000650953	50	50	32	0,020	20	400	2800	1	2.54 €
PB30000650955	75	70	32	0,025	15	300	2100	1	3.28 €
PB30000650957	90	90	42	0,033	30	240	1680	1	5.38 €
PB30000650959	110	100	42	0,067	20	160	1120	1	7.41 €
PB30000650961	125	125	51	0,099	10	80	560	1	9.84 €
PB30000650963	160	150	57	0,127	10	80	320	1	12.25 €

GAMA TRIPLUS

HTSW curva técnica

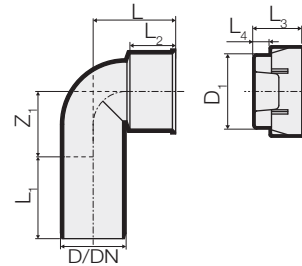

COD.	D/D ₁	DN	Z ₁	L ₁	L ₂	L ₃	L ₄	L	kg				QMM	€/un
PB30000650971	32/46	30	23	51	27	30	10	50	0,040	20	320	1600	20	4.44 €
PB30000650972	40/46	40	23	51	30	30	10	50	0,044	20	160	1120	20	4.44 €
PB30000650973	40/53,5	40	28	52	27	30	10	52	0,047	20	160	1120	20	4.44 €
PB30000650974	50/53,5	50	28	52	28	30	10	52	0,051	20	160	1120	20	4.44 €
PB30000650975	50/60	50	28	52	28	30	10	52	0,054	20	160	1120	20	4.44 €

Redução concêntrica

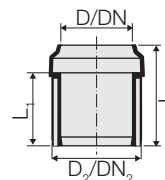

COD.	D/D ₂	DN/DN ₂	L	L ₁	kg				QMM	€/un
PB30000650790	32/40	30/40	65	50	0,021	100	800	4800	100	2.74 €
PB30000650791	40/50	40/50	56	38	0,026	80	640	3200	80	2.74 €
PB30000650793	75/90	70/90	76	61	0,060	20	160	640	20	4.68 €
PB30000650795	90/110	90/100	81,5	65	0,109	20	160	640	20	5.36 €
PB30000650797	110/125	100/125	86	68	0,131	30	120	360	30	11.68 €

HTR redução excêntrica

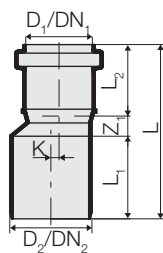

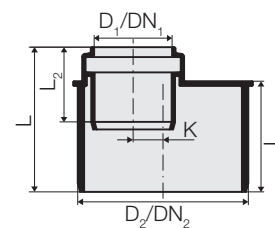

Mod. A



Mod. B



COD.	D ₁ /D ₂	DN ₁ /DN ₂	Mod.	K	Z ₁	L ₁	L ₂	L	kg				QMM	€/un
PB30000650701	32/40	30/40	A	0	11	44	45	100	0,023	50	400	2800	1	2.65 €
PB30000650703	32/50	30/50	A	0	14	47	44	105	0,027	40	320	2240	1	2.65 €
PB30000650705	40/50	40/50	A	5	12	51	44	107	0,050	50	400	2000	1	2.65 €
PB30000650707	40/75	40/70	B	9	-	56	39	74	0,083	30	240	1680	1	3.28 €
PB30000650708	50/75	50/70	A	10	22	52	48	122	0,093	20	160	1120	1	3.43 €
PB30000650709	50/75	50/70	B	4	-	56	42	73	0,090	30	240	1200	1	3.28 €
PB30000650711	40/90	40/90	B	16	-	59	40	77	0,116	20	160	1120	1	4.55 €
PB30000650713	50/90	50/90	B	11	-	61	42	78	0,119	20	160	1120	1	4.55 €

COD.	D ₁ /D ₂	DN ₁ /DN ₂	Mod.	K	Z ₁	L ₁	L ₂	L	kg				QMM	€/un
PB30000650715	75/90	70/90	A	5	3	57	47	107	0,149	20	160	640	1	4.85 €
PB30000650717	40/110	40/100	B	25	-	63	40	79	0,162	20	160	640	20	4.85 €
PB30000650719	50/110	50/100	B	20	-	63	42	80	0,169	20	160	640	1	4.85 €
PB30000650720	75/110	70/100	A	15	28	59	55	142	0,198	20	160	480	1	5.01 €
PB30000650721	75/110	70/100	B	7	-	63	47	80	0,193	20	160	640	1	4.85 €
PB30000650723	90/110	90/100	A	7	3	60	50	113	0,218	20	80	320	1	5.54 €
PB30000650729	110/125	100/125	A	4	6	67	49	122	0,307	20	80	240	1	8.77 €
PB30000650731	110/160	100/150	B	10	-	85	52	103	0,482	1	-	306	1	13.12 €
PB30000650733	125/160	125/150	B	4	-	86	56	105	0,431	1	-	300	1	13.12 €
PB30000650735 *	110/200	100/200	B	10	45	90	55	191	1,006	1	-	90	1	104.66 €
PB30000650739 *	160/200	150/200	A	18	45	93	77	215	1,108	1	-	100	1	111.37 €
PB30000650747 *	200/250	200/250	A	23	51	124	135	310	2,317	1	-	36	1	216.79 €

* Peça soldada.

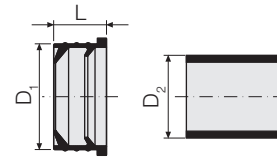

HTGB Morsetto

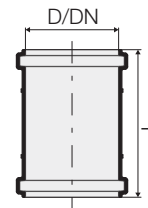

COD.	D ₁	D ₂	L	kg				QMM	€/un
PB10000334003	46	24-32	22	0,026	100	800	8000	100	0.87 €
PB10000334005	46	36-40	22	0,012	150	1200	7200	150	0.87 €
PB10000523011	50	36-40	22	0,026	30	600	4200	30	1.01 €
PB10000523015	53,5	24-32	22	0,029	30	600	4200	30	1.04 €
PB10000523017	53,5	36-40	22	0,025	30	600	4200	30	1.04 €
PB10000523019	60	46-55	24	0,020	30	600	4200	30	1.54 €

HTU união deslizante





COD.	D	DN	L	kg				QMM	€/un
PB30000650801	32	30	86	0,023	60	480	3360	1	2.20 €
PB30000650803	40	40	100	0,057	30	240	1680	1	2.33 €
PB30000650805	50	50	105	0,069	30	240	1680	1	2.54 €
PB30000650807	75	70	120	0,149	20	160	640	1	3.75 €
PB30000650809	90	90	120	0,206	20	160	480	1	5.22 €
PB30000650811	110	100	136	0,307	20	80	240	1	5.81 €
PB30000650813	125	125	147	0,427	20	80	160	1	10.87 €
PB30000650815	160	150	180	0,804	1	-	100	1	16.39 €
PB30000650817	200	200	220	1,543	1	-	45	1	90.04 €
PB30000650819	250	250	290	3,225	1	-	20	1	174.14 €

GAMA TRIPLUS

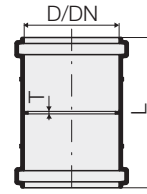
HTMM união dupla

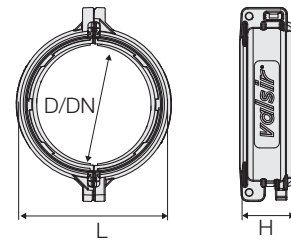

COD.	D	DN	L	T	kg				QMM	€/un
PB30000650851	32	32	85	2	0,023	60	480	3360	1	2.20 €
PB30000650853	40	40	100	2	0,058	30	240	1680	1	2.33 €
PB30000650855	50	50	105	2	0,070	30	240	1680	1	2.54 €
PB30000650857	75	70	120	2	0,149	20	160	640	1	3.75 €
PB30000650859	90	90	120	3	0,207	20	160	480	1	5.22 €
PB30000650861	110	100	136	3	0,311	20	80	240	1	5.81 €
PB30000650863	125	125	147	3	0,433	20	80	160	1	10.87 €
PB30000650865	160	150	180	3	0,827	1	-	100	1	16.39 €
PB30000650867	200	200	220	4	1,572	1	-	45	1	90.04 €
PB30000650869	250	250	290	4	3,371	1	-	22	1	174.14 €

Colar
antideslizamento sem
vedação

COD.	D	L	H	kg		QMM	€/un
PC10000415003	32	51	38	0,043	10	10	6.31 €
PC10000415004	40	63	42	0,057	10	10	6.70 €
PC10000415005	50	77	42	0,070	10	10	7.37 €
PC10000415007	75	100	46	0,091	10	10	8.77 €
PC10000415009	90	117	49	0,113	10	10	11.01 €
PC10000415011	110	141	52	0,150	10	10	19.83 €
PC10000415012	125	159,2	53	0,20	10	10	26.77 €
PC10000415016	160	197,2	57	0,27	10	10	35.57 €
PC10000415020	200	242,2	74	0,44	10	10	58.13 €
PC10000415025	250	306,2	86,5	0,75	10	10	88.85 €

Vedação para colar
antideslizamento

COD.	D	kg		QMM	€/un
PC10000415103	32	0,007	5	10	2.49 €
PC10000415104	40	0,009	5	10	2.49 €
PC10000415105	50	0,011	5	10	2.56 €
PC10000415107	75	0,013	5	10	2.75 €
PC10000415109	90	0,015	5	10	2.81 €
PC10000415111	110	0,017	5	10	3.01 €



BLACKFIRE®: sistema de encaixe para drenagem resistente ao fogo

BLACKFIRE®, RESISTÊNCIA AO FOGO

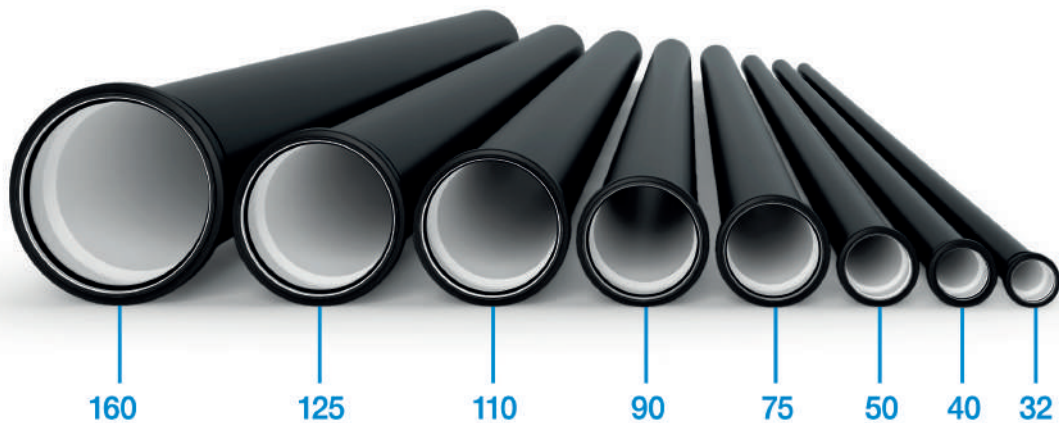

Valsir Blackfire® é o sistema de drenagem composto por tubos e acessórios para a realização de sistemas de drenagem residual e pluvial.

O sistema Blackfire®, como os outros sistemas de drenagem Valsir, é um sistema de encaixe caracterizado por um fácil e rápida instalação. Outra característica do Valsir Blackfire® é que permite obter bons resultados a nível de conforto acústico, bem como de resistência ao fogo segundo a norma DIN 4102 B1.

Ideal para sistemas de drenagem a baixa e alta temperatura, sistema de ventilação de drenagem residual, sistemas de drenagem pluvial no interior de edifícios sejam de âmbito doméstico, comercial, industrial, hospitais ou hotéis.

A ampla gama de tubos e acessórios permite realizar a rede interna de drenagem desde dos ramais individuais dos aparelhos sanitários, dos tubos de queda aos coletores prediais de drenagem.





 Velocidade e extrema facilidade de instalação sem necessidade de auxílio de ferramentas, graças à conexão por encaixe.

 Camada interna branca para facilitar eventuais operações de vídeo inspeção.

 Resistência ao fogo classe B1.

 Resistência mecânica: elevada resistência às solicitações mecânicas em sistemas de drenagem até -10°C.

 Bom conforto acústico: segundo EN 14366 e DIN 4109, valores de 16 dB(A) com um caudal de 2 l/s (certificado P-BA 258/2019e).

 Sistema resistente a pressões negativas até -800 mbar e pressões positivas de 1,5 bar.

 Elevada resistência química às descargas de origem doméstica e industrial.

 Ampla gama de tubos de acessórios: de Ø 32 mm a Ø 160 mm.

 Excepcional resistência aos raios UV. O armazenamento e instalação exterior são permitidos sem qualquer risco de descoloração ou dano.

 Valsir Blackfire® é verde porque é realizado com produtos completamente recicláveis.

 Compatível com todos os outros sistemas de drenagem Valsir.

 Facilidade de conexão com outros sistemas de drenagem (ferro, PE, PVC e PP)

Fraunhofer

Hoch

Fladungen



DE



UKR-SEPRO





UA

GAMA BLACKFIRE

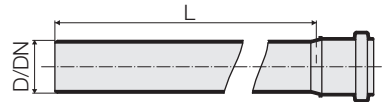
**HTEM tubo
1 boca**



COD.	D	DN	L				QMM	€/un
PB70000660005	32	30	500	30	180	900	30	2.59 €
PB70000660011	32	30	2000	24	120	840	24	7.41 €
PB70000660013	32	30	3000	24	120	840	24	11.19 €
PB70000660025	40	40	500	50	200	600	50	2.59 €
PB70000660031	40	40	2000	20	100	500	20	7.41 €
PB70000660033	40	40	3000	20	100	500	20	11.97 €
PB70000660045	50	50	500	35	140	420	35	2.78 €
PB70000660051	50	50	2000	30	120	360	30	8.22 €
PB70000660053	50	50	3000	30	120	360	30	12.84 €
PB70000660065	75	70	500	20	80	240	20	4.82 €
PB70000660071	75	70	2000	20	60	180	20	12.99 €
PB70000660073	75	70	3000	20	60	180	20	19.26 €
PB70000660085	90	90	500	24	96	192	24	6.57 €
PB70000660091	90	90	2000	10	-	120	10	19.61 €
PB70000660093	90	90	3000	10	-	120	10	28.40 €
PB70000660105	110	100	500	15	60	120	15	7.45 €
PB70000660111	110	100	2000	15	30	90	15	21.93 €
PB70000660113	110	100	3000	15	30	90	15	31.71 €
PB70000660125	125	125	500	6	48	96	6	10.66 €
PB70000660131	125	125	2000	8	16	64	8	31.81 €
PB70000660133	125	125	3000	8	16	64	8	45.03 €
PB70000660145	160	150	500	1	-	36	1	17.03 €
PB70000660151	160	150	2000	6	12	36	6	50.23 €
PB70000660153	160	150	3000	6	12	36	6	72.02 €

HTB curva 15°

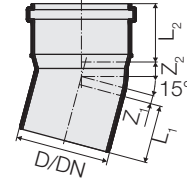

COD.	D	DN	Z ₁	L ₁	Z ₂	L ₂				QMM	€/un
PB70000660401	32	30	3	48	6	44	80	640	4480	80	1.39 €
PB70000660411	40	40	4	47	8	44	50	400	2000	50	1.47 €
PB70000660421	50	50	4	48	8	46	30	240	1680	30	1.92 €
PB70000660431	75	70	7	53	11	52	20	160	640	20	3.11 €
PB70000660441	90	90	8	56	14	56	20	160	480	20	4.27 €
PB70000660451	110	100	9	61	16	59	20	80	240	20	4.80 €
PB70000660461	125	125	10	66	17	64	20	80	160	20	8.88 €
PB70000660471	160	150	-	82	18	77	1	-	100	1	13.96 €

HTB curva 30°

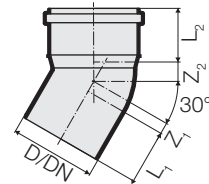

COD.	D	DN	Z ₁	L ₁	Z ₂	L ₂				QMM	€/un
PB70000660403	32	30	5	48	8	44	80	640	4480	80	1.39 €
PB70000660413	40	40	7	47	10	44	50	400	2000	50	1.47 €
PB70000660423	50	50	8	48	12	46	30	240	1680	30	1.92 €
PB70000660433	75	70	12	53	17	52	20	160	640	20	3.11 €
PB70000660443	90	90	14	56	20	56	20	80	320	20	4.27 €
PB70000660453	110	100	17	61	23	59	20	80	240	20	4.80 €
PB70000660463	125	125	18	66	26	64	20	80	160	20	8.88 €
PB70000660473	160	150	-	82	29	77	1	-	90	1	13.96 €

GAMA BLACKFIRE

HTB curva 45°

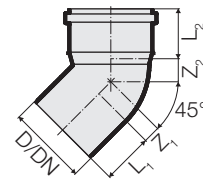

COD.	D	DN	Z ₁	L ₁	Z ₂	L ₂				QMM	€/un
PB70000660405	32	30	8	45	10	44	80	640	3200	50	1.39 €
PB70000660415	40	40	10	47	14	44	50	400	2000	30	1.39 €
PB70000660425	50	50	11	48	17	46	30	240	1200	20	1.76 €
PB70000660435	75	70	18	53	22	52	20	160	480	20	3.11 €
PB70000660445	90	90	21	56	26	56	20	80	320	20	4.27 €
PB70000660455	110	100	25	61	31	59	20	80	240	15	4.45 €
PB70000660465	125	125	28	66	35	64	15	60	120	1	8.88 €
PB70000660475	160	150	-	82	41	77	1	-	80	1	13.96 €

HTB curva 67°30'

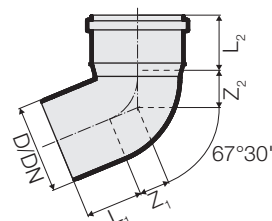

COD.	D	DN	Z ₁	L ₁	Z ₂	L ₂				QMM	€/un
PB70000660407	32	30	10	51	15	47	60	480	3360	60	1.47 €
PB70000660417	40	40	15	47	19	44	50	400	2000	50	1.60 €
PB70000660427	50	50	18	48	22	46	30	240	1200	30	2.42 €
PB70000660437	75	70	28	53	33	52	20	160	480	20	4.06 €
PB70000660447	90	90	33	56	38	56	20	80	320	20	4.80 €
PB70000660457	110	100	40	61	45	59	20	80	160	20	5.05 €
PB70000660467	125	125	43	66	51	64	15	60	120	15	13.10 €

HTB curva 87°30'

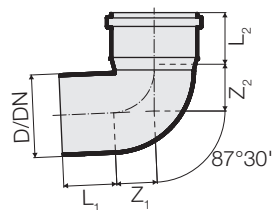

COD.	D	DN	Z ₁	L ₁	Z ₂	L ₂				QMM	€/un
PB70000660409	32	30	20	45	19	44	60	480	3360	60	1.47 €
PB70000660419	40	40	22	47	25	44	50	400	2000	50	1.47 €
PB70000660429	50	50	26	48	30	46	30	240	1200	30	1.94 €
PB70000660439	75	70	40	53	43	52	20	160	480	20	4.06 €
PB70000660449	90	90	46	56	51	56	20	80	320	20	4.58 €
PB70000660459	110	100	57	61	61	59	20	80	160	20	4.74 €
PB70000660469	125	125	62	66	70	64	10	40	120	10	13.10 €
PB70000660479	160	150	-	82	85	77	1	-	65	1	21.68 €

HTEA forquilha 45°

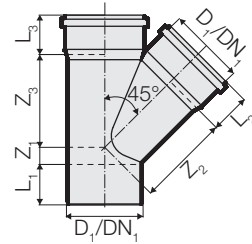

COD.	D ₁	DN ₁	Z ₁	L ₁	Z ₂	L ₂	Z ₃	L ₃				QMM	€/un
PB70000660501	32	32	7	50	44	44	44	44	40	320	1600	40	3.02 €
PB70000660507	40	40	10	46	49	44	49	44	20	160	1120	20	3.23 €
PB70000660513	50	50	12	50	61	46	61	46	20	160	640	20	3.88 €
PB70000660519	75	70	19	53	96	52	96	52	20	80	240	20	5.48 €
PB70000660525	90	90	21	56	110	56	110	56	20	80	160	20	8.28 €
PB70000660531	110	100	25	61	135	59	135	59	10	40	80	10	9.31 €
PB70000660537	125	125	28	66	152	65	152	65	5	20	60	5	32.31 €
PB70000660543	160	150	-	82	194	77	195	77	1	-	32	1	49.97 €

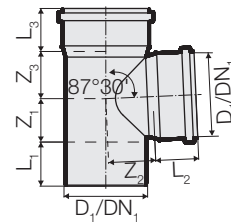
HTEA forquilha
87°30'

COD.	D ₁	DN ₁	Z ₁	L ₁	Z ₂	L ₂	Z ₃	L ₃				QMM	€/un
PB70000660505	32	32	21	45	17	52	17	52	40	320	1600	40	3.02 €
PB70000660511	40	40	19	46	24	44	28	44	20	160	1120	20	3.23 €
PB70000660517	50	50	28	50	29	46	29	46	20	160	800	20	3.88 €
PB70000660523	75	70	39	53	46	52	46	52	20	80	240	20	5.48 €
PB70000660529	90	90	48	56	52	56	52	56	20	80	160	20	8.28 €
PB70000660535	110	100	56	61	65	59	65	59	10	40	120	10	9.31 €
PB70000660541	125	125	65	66	71	65	71	65	10	40	80	10	32.31 €
PB70000660547	160	150	-	82	89	78	93	77	1	-	40	1	49.97 €

GAMA BLACKFIRE

Forquilha curva
87°30'

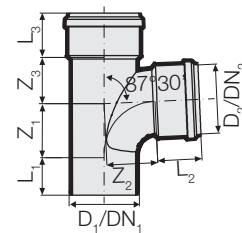

COD.	D ₁ /D ₂	DN ₁ /DN ₂	Z ₁	L ₁	Z ₂	L ₂	Z ₃	L ₃				QMM	€/un
PB70000660694	90/90	90/90	57	56	64	56	47	59	20	80	160	20	9.69 €
PB70000660695	110/75	100/70	48	81	54	52	58	59	10	60	120	10	9.69 €
PB70000660696	110/90	100/90	57	72	64	56	58	59	10	40	120	10	10.13 €
PB70000660693	110/110	100/100	69	64	78	66	58	59	8	32	96	8	17.06 €

HTEA forquilha
redução 45°

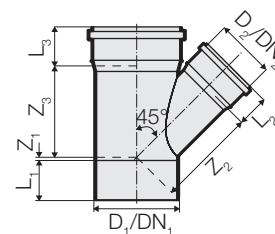

COD.	D ₁ /D ₂	DN ₁ /DN ₂	Z ₁	L ₁	Z ₂	L ₂	Z ₃	L ₃				QMM	€/un
PB70000660551	40/32	40/30	5	52	45	47	42	52	40	320	1280	40	3.23 €
PB70000660557	50/40	50/40	5	50	56	44	54	46	20	160	800	20	3.88 €
PB70000660563	75/40	70/40	-7	46	79	44	71	52	25	100	300	25	5.48 €
PB70000660569	75/50	70/50	-1	54	84	46	76	54	25	100	300	25	5.48 €
PB70000660575	90/40	90/40	-10	56	87	44	76	56	20	80	240	20	8.28 €
PB70000660581	90/50	90/50	-9	56	90	46	83	56	20	80	240	20	8.28 €
PB70000660587	110/40	100/40	-24	61	99	44	89	59	20	80	160	20	9.31 €
PB70000660593	110/50	100/50	-17	61	106	46	79	59	20	80	160	20	9.31 €
PB70000660599	110/75	100/70	1	61	121	52	112	59	15	60	120	15	9.31 €
PB70000660605	125/50	125/50	-24	66	114	46	111	65	10	40	120	10	21.11 €
PB70000660611	125/110	125/100	18	66	146	59	142	65	8	32	64	8	21.11 €
PB70000660617	160/110	150/100	-	82	-	-	167	77	1	-	40	1	33.43 €
PB70000660623	160/125	150/125	-	82	-	-	170	77	1	-	40	1	33.43 €

◆ Forquilha simples com redução inserida na derivação.

HTEA forquilha redução 87°30'

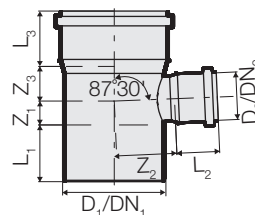

COD.	D ₁ /D ₂	DN ₁ /DN ₂	Z ₁	L ₁	Z ₂	L ₂	Z ₃	L ₃				QMM	€/un
PB70000660555	40/32	40/30	18	52	23	50	20	50	40	320	1280	40	3.23 €
PB70000660561	50/40	50/40	23	50	29	44	24	46	25	200	800	25	3.88 €
PB70000660567	75/40	70/40	22	53	47	44	30	52	25	100	300	25	5.48 €
PB70000660573	75/50	70/50	27	53	46	46	35	52	25	100	300	25	5.48 €
PB70000660579	90/40	90/40	23	56	50	44	29	56	15	60	240	15	8.28 €
PB70000660585	90/50	90/50	24	56	50	46	34	56	20	80	240	20	8.28 €
PB70000660591	110/40	100/40	21	61	62	44	32	59	20	80	240	20	9.31 €
PB70000660597	110/50	100/50	26	61	64	46	37	59	20	80	240	20	9.31 €
PB70000660603	110/75	100/70	38	61	67	52	49	59	15	60	120	15	9.31 €
PB70000660691 ♦	110/90	100/90	56	61	90	60	65	59	10	40	120	10	10.92 €
PB70000660609	125/50	125/50	28	66	68	46	36	65	10	40	120	10	21.11 €
PB70000660615	125/110	125/100	58	66	72	59	64	65	8	32	96	8	21.11 €
PB70000660621	160/110	150/100	-	82	-	-	67	77	1	-	65	1	33.43 €
PB70000660627	160/125	150/125	-	82	-	-	75	77	1	-	65	1	33.43 €

♦ Forquilha simples com redução inserida na derivação.

HTDA forquilha dupla 45°

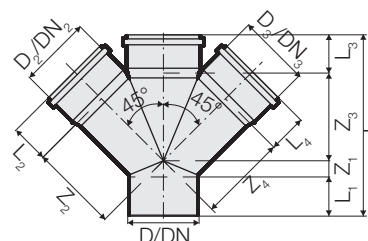

COD.	D _{1/2/3}	DN _{1/2/3}	L	Z ₁	L ₁	Z _{2/3/4}	L _{2/3/4}				QMM	€/un
PB70000660655	110/110/110	100/100/100	280	25	61	136	59	5	20	60	5	18.53 €

GAMA BLACKFIRE

VBF
Forquilha
misturadora

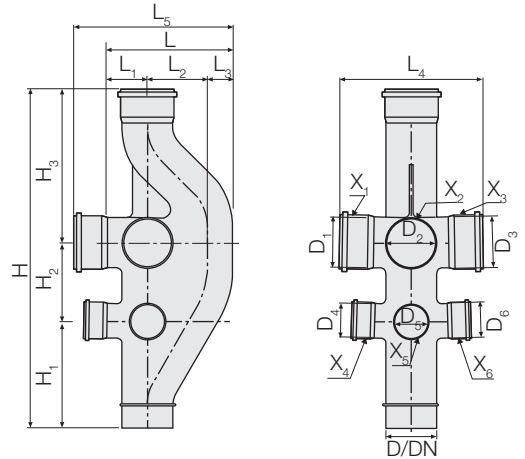

COD.	D	DN	D _{1/2/3}	D _{4/5/6}	L	L ₁	L ₂	L ₃	L ₄	L ₅	H	H ₁	H ₂	H ₃	€/un
PB70000661X ₁ X ₂ X ₃ X ₄ X ₅ X ₆ *	110	100	110	75	265	85	130	50	300	345	780	245	170	365	**

* O "X" assume o valor de 0 a entrada não for necessária, caso contrário assume o valor de 1 e é soldado um encaixe. Está previsto um lote mínimo por encomenda.

** Sob encomenda.

**HTRE forquilha de
inspeção com tampa
roscada**

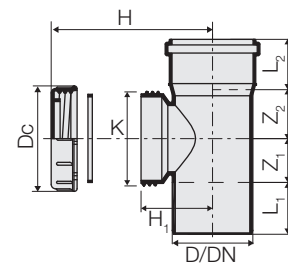

COD.	D	DN	Z ₁	L ₁	Z ₂	L ₂	H	Dc	K	H ₁				QMM	€/un
PB70000660901	50	50	36	48	35	46	60	90	74	57	20	160	640	20	6.99 €
PB70000660903	75	70	40	53	43	52	80	90	74	66	20	80	240	20	8.75 €
PB70000660905	90	90	49	58	55	56	8	120	105	80	20	80	160	20	11.60 €
PB70000660907	110	100	55	61	65	59	100	120	105	90	15	60	120	15	13.62 €
PB70000660909	125	125	65	66	71	65	105	150	128	98	10	40	80	10	26.63 €
PB70000660911	160	150	64	75	75	73	105	150	128	118	1	-	62	1	40.92 €

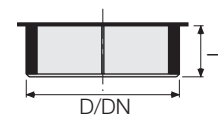

**HTM tampão de
fecho**

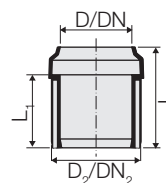

COD.	D	DN	L				QMM	€/un
PB70000660951	40	40	32	40	800	5600	40	1.47 €
PB70000660953	50	50	32	20	400	2800	20	2.25 €
PB70000660955	75	70	32	15	300	2100	15	2.94 €
PB70000660957	90	90	42	30	240	1680	30	4.83 €
PB70000660959	110	100	42	20	160	1120	20	6.68 €
PB70000660961	125	125	51	10	80	560	10	8.88 €
PB70000660963	160	150	57	10	80	320	10	11.03 €

Redução concêntrica



COD.	D/D ₂	DN/DN ₂	L	L ₁				QMM	€/un
PB70000660790	32/40	30/40	65	50	100	800	4800	100	2.37 €
PB70000660791	40/50	40/50	56	38	80	640	3200	80	2.37 €
PB70000660793	75/90	70/90	76	61	20	160	640	20	4.23 €
PB70000660795	90/110	90/100	81,5	65	20	160	640	20	4.83 €
PB70000660797	110/125	100/125	86	68	30	120	360	30	10.52 €

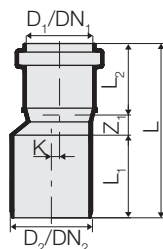

HTR redução excêntrica

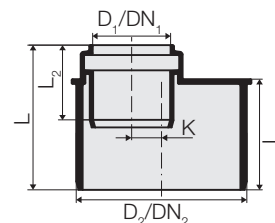

Mod. A



Mod. B

COD.	D ₁ /D ₂	DN ₁ /DN ₂	Mod.	K	Z ₁	L ₁	L ₂	L				QMM	€/un
PB70000660701	32/40	30/40	A	0	11	44	45	100	50	400	2800	50	2.29 €
PB70000660703	32/50	30/50	A	0	14	47	44	105	40	320	2240	40	2.29 €
PB70000660705	40/50	40/50	A	5	12	51	44	107	50	400	2000	50	2.29 €
PB70000660707	40/75	40/70	B	9	-	56	39	74	30	240	1680	30	2.94 €
PB70000660711	40/90	40/90	B	16	-	59	40	77	20	160	1120	20	4.10 €
PB70000660717	40/110	40/100	B	25	-	63	40	79	20	160	640	20	4.36 €
PB70000660708	50/75	50/70	A	10	22	52	48	122	20	160	1120	20	3.07 €
PB70000660709	50/75	50/70	B	4	-	56	42	73	30	240	1200	30	2.94 €
PB70000660713	50/90	50/90	B	11	-	61	42	78	20	160	1120	20	4.10 €
PB70000660719	50/110	50/100	B	20	-	63	42	80	20	160	640	20	4.36 €
PB70000660715	75/90	90/70	A	5	3	57	47	107	20	160	640	20	4.36 €
PB70000660720	75/110	70/100	A	15	28	59	55	142	20	160	480	20	4.53 €
PB70000660721	75/110	70/100	B	7	-	63	47	80	20	160	640	20	4.36 €
PB70000660723	90/110	90/100	A	7	3	60	50	113	20	80	320	20	4.96 €
PB70000660729	110/125	100/125	A	4	6	67	49	122	20	80	240	20	7.89 €
PB70000660731	110/160	100/150	B	10	-	85	52	103	1	-	306	1	11.81 €
PB70000660733	125/160	125/150	B	4	-	86	56	105	1	-	300	1	11.81 €

GAMA BLACKFIRE

HTU união deslizante

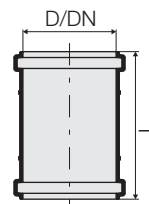

COD.	D	DN	L				QMM	€/un
PB70000660801	32	30	86	60	480	3360	60	1.90 €
PB70000660803	40	40	100	30	240	1680	30	2.03 €
PB70000660805	50	50	105	30	240	1680	30	2.21 €
PB70000660807	75	70	120	20	160	640	20	3.37 €
PB70000660809	90	90	120	20	160	480	20	4.70 €
PB70000660811	110	100	136	20	80	240	20	5.22 €
PB70000660813	125	125	147	20	80	160	20	9.79 €
PB70000660815	160	150	180	1	-	100	1	14.65 €

HTMM união dupla

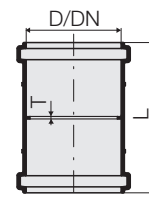

COD.	D	DN	L	T				QMM	€/un
PB70000660851	32	32	85	2	60	480	3360	60	1.90 €
PB70000660853	40	40	100	2	30	240	1680	30	2.03 €
PB70000660855	50	50	105	2	30	240	1680	30	2.21 €
PB70000660857	75	70	120	2	20	160	640	20	3.37 €
PB70000660859	90	90	120	3	20	160	480	20	4.70 €
PB70000660861	110	100	136	3	20	80	240	20	5.22 €
PB70000660863	125	125	147	3	20	80	160	20	9.79 €
PB70000660865	160	150	180	3	1	-	100	1	14.65 €

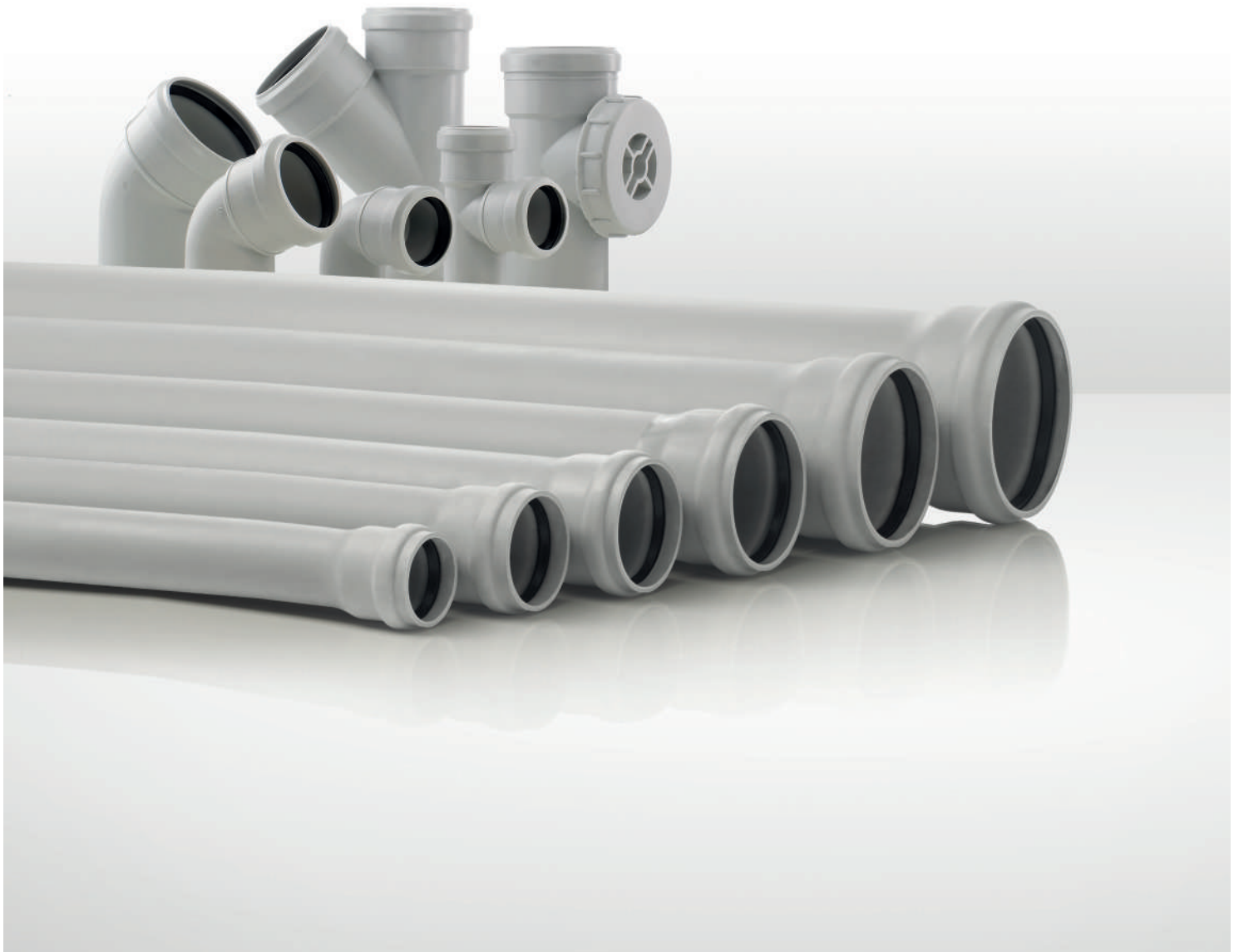

SILERE[®]: a excelência em sistemas de drenagem silenciosos

SILERE[®], O SISTEMA DE DRENAGEM INSONORIDADO DE ENCAIXE DE EXCELÊNCIA

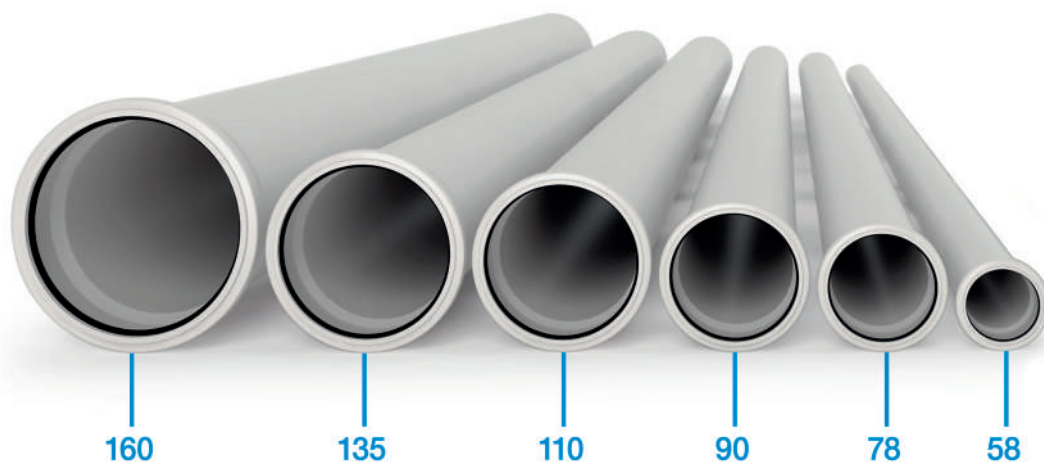

Nos últimos anos assistiu-se a um aumento da atenção dada ao ruído gerado nos sistemas de drenagem no interior dos edifícios, envolvendo vários aspetos, tais como planeamento urbano, técnicas construtivas, distribuição de compartimentos e o isolamento acústicos dos sistemas.

Silere[®] é o sistema de encaixe composto por tubos e acessórios industrializado, produzido e patenteado pela Valsir que responde a estas exigências garantindo os níveis de silêncio nos sistemas de drenagem como requerido pelos regulamentos legislativos e normativos em vigor.





Excelentes performance fono-isolantes do sistema:, 6 dB(A) com um caudal de 2 l/s.



Ampla gama de acessórios de interligação com outros sistemas de drenagem como o ferro, PE, PP, PVC.



Elevada resistência ao impacto a temperatura baixas (até -20°C).



Baixo coeficiente de dilatação térmica.



Elevada velocidade e facilidade de instalação sem a utilização de qualquer ferramenta particular, graças ao sistema de união por encaixe.



O encaixe por abocardamento não necessita da utilização suplementar de colas ou solventes nocivos.



Resistência a descargas descontinuas com temperaturas até 95°C.



O produto, a sua reciclabilidade e os processos produtivos são baseados nos princípios do Green Building.



Elevada resistência química às substâncias dissolvidas e presentes nas descargas civis e industriais.

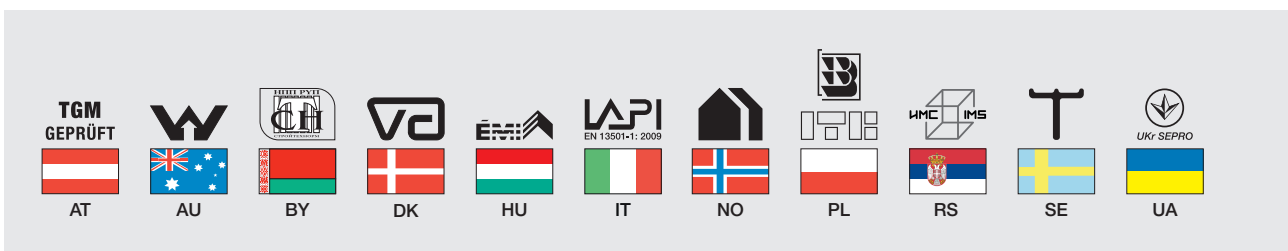

GAMA SILERE

HTEM tubo 1 boca

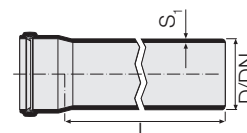

COD.	D	DN	s ₁	L	kg		QMM	€/un
PB40000220005	58	50	4,0	500	0,697	4	4	9.42 €
PB40000220007	58	50	4,0	1000	1,274	16	16	15.46 €
PB40000220009	58	50	4,0	2000	2,500	16	16	27.49 €
PB40000220011	58	50	4,0	3000	3,750	16	1	39.50 €
PB40000220025	78	70	4,5	500	1,059	4	4	9.99 €
PB40000220027	78	70	4,5	1000	1,967	16	16	16.28 €
PB40000220029	78	70	4,5	2000	3,750	16	16	28.86 €
PB40000220031	78	70	4,5	3000	5,500	16	1	41.40 €
PB40000220045	90	90	4,5	500	0,013	4	4	11.45 €
PB40000220047	90	90	4,5	1000	2,282	12	12	18.71 €
PB40000220049	90	90	4,5	2000	4,250	12	12	33.33 €
PB40000220050	90	90	4,5	3000	6,500	12	1	49.03 €
PB40000220055	110	100	5,4	500	1,753	4	4	12.95 €
PB40000220057	110	100	5,4	1000	3,500	15	15	21.28 €
PB40000220059	110	100	5,4	2000	6,250	15	15	38.12 €
PB40000220061	110	100	5,4	3000	9,500	15	1	55.66 €
PB40000220075	135	125	5,6	500	2,405	4	4	18.28 €
PB40000220077	135	125	5,6	1000	4,500	8	8	30.57 €
PB40000220079	135	125	5,6	2000	8,500	8	8	55.28 €
PB40000220081	135	125	5,6	3000	11,750	8	1	76.20 €
PB40000220095	160	150	5,6	500	2,759	4	4	22.65 €
PB40000220097	160	150	5,6	1000	5,250	8	8	38.52 €
PB40000220099	160	150	5,6	2000	5,000	8	8	69.12 €
PB40000220101	160	150	5,6	3000	14,500	8	1	102.78 €

HTB curva 15°

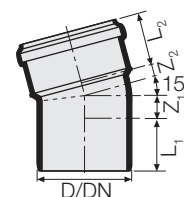

COD.	D	DN	Z ₁	L ₁	Z ₂	L ₂	kg		QMM	€/un
PB40000221001	58	50	4	70	8	55	0,185	4	4	8.21 €
PB40000221011	78	70	6	60	10	60	0,261	4	4	8.21 €
PB40000221021	90	90	8	60	8	60	0,305	4	4	10.92 €
PB40000221031	110	100	27	61	15	65	0,521	4	4	11.71 €
PB40000221041	135	125	29	64	10	70	0,720	4	4	18.29 €
PB40000221051	160	150	13	66	19	70	0,914	4	4	25.34 €

HTB curva 30°

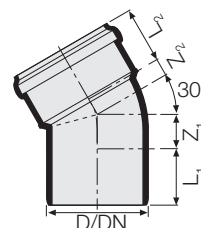

COD.	D	DN	Z ₁	L ₁	Z ₂	L ₂	kg		QMM	€/un
PB40000221003	58	50	8	70	16	55	0,190	4	4	8.33 €
PB40000221013	78	70	11	60	30	60	0,276	4	4	8.33 €
PB40000221023	90	90	14	60	14	60	0,330	4	4	11.51 €
PB40000221033	110	100	37	61	19	65	0,568	4	4	12.07 €
PB40000221043	135	125	38	64	45	70	0,797	4	4	18.65 €
PB40000221053	160	150	24	66	30	70	1,031	4	4	25.34 €

HTB curva 45°

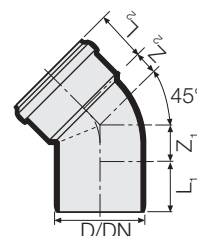

COD.	D	DN	Z ₁	L ₁	Z ₂	L ₂	kg		QMM	€/un
PB40000221005	58	50	28	70	17	55	0,196	4	1	8.73 €
PB40000221015	78	70	37	60	21	60	0,302	4	1	9.13 €
PB40000221025	90	90	22	60	20	60	0,343	4	1	11.64 €
PB40000221035	110	100	44	61	28	65	0,611	4	1	12.63 €
PB40000221045	135	125	50	64	34	70	0,875	4	1	18.81 €
PB40000221055	160	150	30	66	42	70	1,148	4	1	25.22 €

HTB curva 87°30'

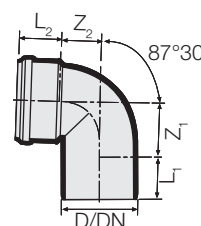

COD.	D	DN	Z ₁	L ₁	Z ₂	L ₂	kg		QMM	€/un
PB40000221009	58	50	47	70	32	55	0,229	4	1	9.36 €
PB40000221019	78	70	62	60	42	60	0,359	4	1	9.36 €
PB40000221029	90	80	49	60	42	60	0,427	4	1	12.40 €
PB40000221039	110	100	78	61	58	65	0,743	4	1	13.27 €
PB40000221049	135	125	96	64	102	70	1,096	4	1	21.40 €
PB40000221059	160	150	83	66	89	70	1,496	4	1	30.17 €

GAMA SILERE

HTEA forquilha 45°

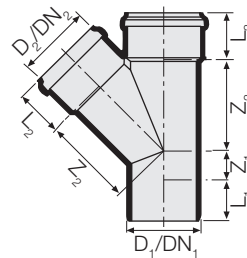

COD.	D ₁ /D ₂	DN ₁ /DN ₂	Z ₁	L ₁	Z ₂	L ₂	Z ₃	L ₃	kg		QMM	€/un
PB40000222005	58/58	50/50	12	70	75	55	75	55	0,375	4	1	15.74 €
PB40000222007	78/58	70/50	2	60	99	60	100	55	0,528	4	1	15.74 €
PB40000222009	78/78	70/70	16	60	99	60	99	60	0,610	4	1	17.01 €
PB40000222011	90/58	80/50	19	60	113	60	113	55	0,614	4	1	20.04 €
PB40000222013	90/90	90/90	19	60	116	60	113	60	0,736	4	1	16.85 €
PB40000222015	110/58	100/50	1	61	110	65	97	55	0,789	4	1	19.57 €
PB40000222017	110/78	100/70	21	61	122	65	115	60	0,905	4	1	21.32 €
PB40000222018	110/90	100/90	44	61	168	60	136	70	1,347	4	1	24.47 €
PB40000222019	110/110	100/100	44	61	136	70	136	70	1,282	4	1	23.28 €
PB40000222021	135/110	125/100	49	64	169	70	169	65	1,699	2	1	35.42 €
PB40000222023	135/135	125/125	49	64	169	70	169	70	1,888	2	1	44.07 €
PB40000222025	160/110	150/100	36	95	180	70	200	70	1,831	2	1	47.70 €
PB40000222027	160/160	150/150	36	95	200	70	200	70	2,493	2	1	61.91 €

HTEA Forquilha
87°30'

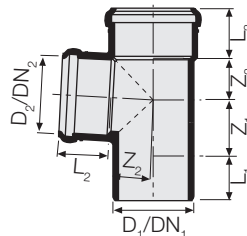

COD.	D ₁ /D ₂	DN ₁ /DN ₂	Z ₁	L ₁	Z ₂	L ₂	Z ₃	L ₃	kg		QMM	€/un
PB40000224005	58/58	50/50	28	70	32	55	32	55	0,310	4	1	16.57 €
PB40000224007	78/58	70/50	27	60	43	60	43	55	0,419	4	1	15.74 €
PB40000224009	78/78	70/70	37	60	43	60	43	60	0,474	4	1	17.01 €
PB40000224015	110/58	100/50	47	61	61	65	27	55	0,680	4	1	19.61 €
PB40000224017	110/78	100/70	60	61	61	65	43	55	0,774	4	1	21.32 €
PB40000224018	110/90	100/90	78	91	91	60	58	70	1,110	4	1	24.47 €
PB40000224019	110/110	100/100	78	61	58	70	58	70	0,988	4	1	23.28 €
PB40000224021	135/110	125/100	90	64	72	70	72	65	1,402	2	1	35.42 €
PB40000224023	135/135	125/125	90	64	72	70	72	70	1,431	2	1	44.46 €

Forquilha curva 87°30'

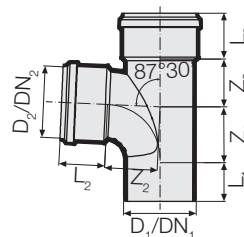

COD.	D ₁ /D ₂	DN ₁ /DN ₂	Z ₁	L ₁	Z ₂	L ₂	Z ₃	L ₃	kg		QMM	€/un
PB40000238011	110/110	100/100	78	65	80	70	72	70	1,098	4	1	32.51 €

HTDA forquilha dupla 87°30'

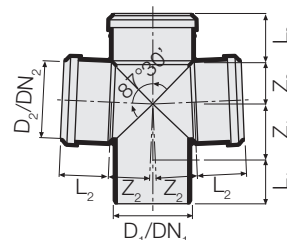

COD.	D ₁ /D ₂	DN ₁ /DN ₂	Z ₁	L ₁	Z ₂	L ₂	Z ₃	L ₃	kg		QMM	€/un
PB40000225011	110/110	100/100	78	61	58	70	58	70	1,168	2	2	59.76 €
PB40000225013	135/110	125/100	80	84	74	71	72	70	1,510	2	2	82.34 €

Peça soldada.

HTED forquilha de ângulo 87°30'

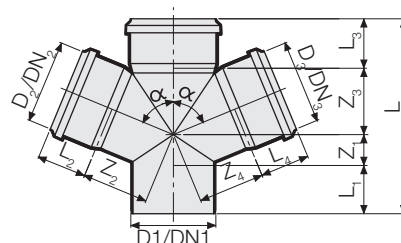
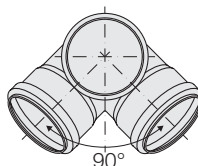

COD.	D _{1/2/3}	DN _{1/2/3}	α	Z ₁	Z _{2/4}	Z ₃	L	L ₁	L _{2/4}	L ₃	kg				QMM	€/un
PB40000225014	110/110/110	100/100/100	87°30'	54	72	65	242	63	58	61	0,840	5	20	60	5	53.43 €

Forquilha paralela

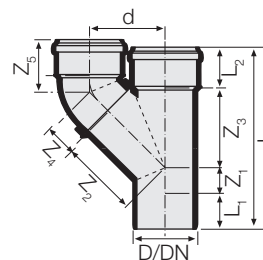

COD.	D	DN	Z ₁	Z ₂	Z ₃	Z ₄	Z ₅	d	L ₁	L	kg		QMM	€/un
PB40000233011	110	100	44	136	136	56	89	134	61	310	1,548	2	2	85.30 €

Peça soldada.

GAMA SILERE

VBF
Forquilha
misturadora

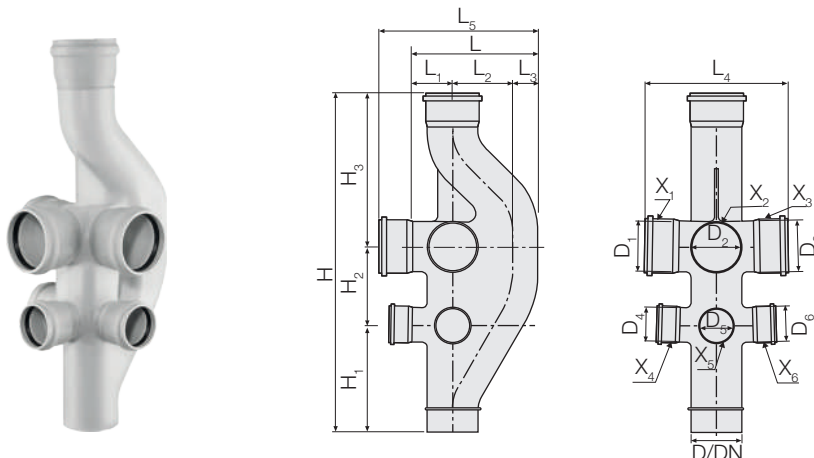

COD.	D	DN	D _{1/2/3}	D _{4/5/6}	L	L ₁	L ₂	L ₃	L ₄	L ₅	H	H ₁	H ₂	H ₃	€/un
PB40000273X ₁ X ₂ X ₃ X ₄ X ₅ X ₆ *	110	100	110	78	265	85	130	50	300	345	780	245	170	365	**

* O "X" assume o valor de 0 a entrada não for necessária, caso contrário assume o valor de 1 e é soldado um encaixe. Está previsto um lote mínimo por encomenda.

** Sob encomenda.

**HTRE forquilha de
inspeção com tampa
roscada**

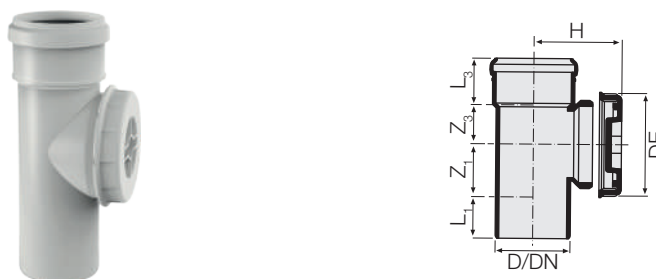

COD.	D	DN	Z ₁	L ₁	Z ₃	L ₃	H	DE	kg		QMM	€/un
PB40000227005	58	50	28	70	32	55	72	90	0,405	4	1	19.92 €
PB40000227007	78	70	37	60	43	60	82	120	0,619	4	1	21.76 €
PB40000227011	110	100	78	61	58	70	110	150	1,087	4	1	30.68 €
PB40000227013	135	125	90	64	72	65	115	150	1,455	4	1	63.70 €
PB40000227015	160	150	80	95	80	70	120	150	1,768	2	1	80.68 €

**HTR redução
excêntrica**

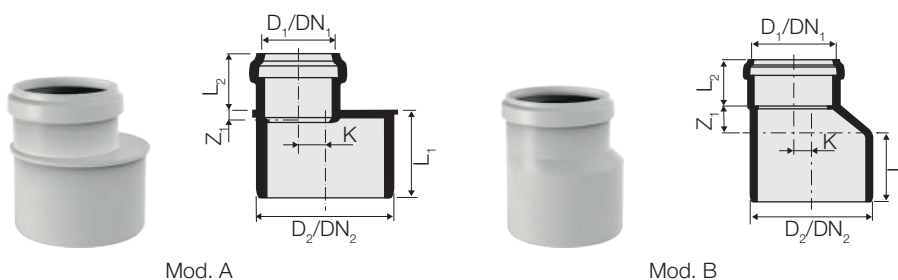

COD.	D ₁ /D ₂	DN ₁ /DN ₂	Mod.	K	Z ₁	L ₁	L ₂	kg		QMM	€/un
PB40000226005	58/78	50/70	A	5	10	60	55	0,190	4	1	6.26 €
PB40000226007	58/90	50/90	A	11	10	67	55	0,227	4	1	8.85 €

COD.	D ₁ /D ₂	DN ₁ /DN ₂	Mod.	K	Z ₁	L ₁	L ₂	kg		QMM	€/un
PB40000226009	78/90	70/90	A	0	15	67	60	0,239	4	1	9.25 €
PB40000226011	58/110	50/100	A	22	10	70	55	0,313	4	1	8.09 €
PB40000226013	78/110	70/100	A	11	10	70	60	0,349	4	1	8.21 €
PB40000226015	90/110	90/100	A	5	10	70	60	0,343	4	1	10.64 €
PB40000226017	110/135	100/125	B	7	15	85	65	0,565	4	1	13.51 €
PB40000226019	110/160	100/150	B	23	35	90	65	0,769	4	1	17.89 €
PB40000226021	135/160	125/150	B	10	32	90	70	0,817	4	1	20.04 €

Tampão

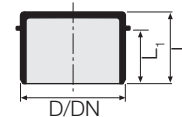

COD.	D	DN	L ₁	L	kg		QMM	€/un
PB40000230005	58	50	50	65	0,177	4	1	4.43 €
PB40000230007	78	70	51	66	0,147	4	1	6.38 €
PB40000230009	90	90	51	66	0,162	4	1	7.93 €
PB40000230011	110	100	56	72	0,287	4	1	9.49 €
PB40000230013	135	125	60	77	0,406	4	1	13.86 €
PB40000230015	160	150	45	63,5	0,449	4	1	17.89 €

Abraçadeira tampão

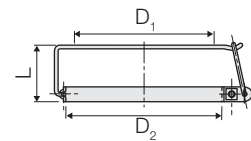

COD.	D	D ₁	D ₂	L	kg		QMM	€/un
PB40000250005	58/50	59	69	41	0,075	10	10	31.72 €
PB40000250007	78/70	79	99	41	0,087	10	10	40.04 €
PB40000250009	90/90	91	102	41	0,094	10	10	40.99 €
PB40000250011	110/100	111	123	46	0,115	10	10	41.44 €
PB40000250013	135/125	136	146	47	0,132	10	10	43.99 €
PB40000250015	160/150	161	181	47	0,142	10	10	49.40 €

HTU união deslizante

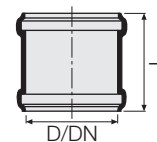

COD.	D	DN	L	kg		QMM	€/un
PB40000228005	58	50	105	0,165	4	1	5.58 €
PB40000228007	78	70	107	0,233	4	1	5.58 €
PB40000228011	110	100	117	0,393	4	1	5.78 €
PB40000228013	135	125	126	0,535	4	1	7.69 €
PB40000228015	160	150	147	0,742	4	1	12.63 €
						1	15.38 €

GAMA SILERE

União dupla

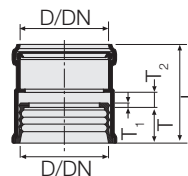

COD.	D	DN	T	T ₁	T ₂	L	kg		QMM	€/un
PB40000229005	58	50	48	5	15	119	0,228	4	1	5.04 €
PB40000229007	78	70	48	6	16	119	0,303	4	1	5.61 €
PB40000229009	90	90	47	6	16	124	0,360	4	1	6.01 €
PB40000229011	110	100	48	6	16	124	0,484	4	1	6.42 €
PB40000229013	135	125	65	6	16	145	0,726	4	1	10.96 €
PB40000229015	160	150	65	6	16	147	0,858	4	1	12.92 €

Ligação
PP/HDPE - SILERE

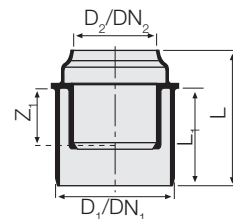

COD.	D ₁ /D ₂	DN ₁ /DN ₂	Z ₁	L	L ₁	kg		QMM	€/un
PB40000231001	58/40	50/40	30	67	50	0,035	4	1	4.95 €
PB40000231003	58/50	50/50	25	86	60	0,043	4	1	5.23 €
PB40000231005 *	78/50	70/50	37	75	60	0,052	4	1	5.30 €
PB40000231007	78/75	70/70	0	112	60	0,060	4	1	5.30 €
PB40000231013	135/125	125/125	0	138	70	0,205	2	1	7.90 €

* Excêntrico

Ligação
SILERE - PP/HDPE

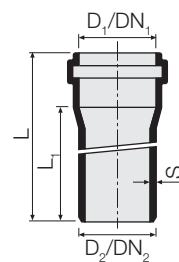

COD.	D ₁ /D ₂	DN ₁ /DN ₂	L	L ₁	s ₁	kg		QMM	€/un
PB40000237003	58/50	50/50	145	60	2,5	0,134	4	4	13.31 €
PB40000237007	78/75	70/70	150	70	3,5	0,203	4	4	13.55 €
PB40000237013	135/125	125/125	190	75	3,5	0,610	2	2	39.21 €

Ligação HDPE - SILERE

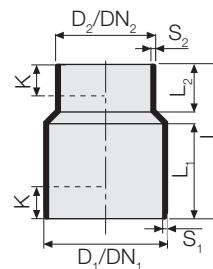

COD.	D ₁ /D ₂	DN ₁ /DN ₂	S ₁ /S ₂	L	L ₁	L ₂	K	kg				QMM	€/un
PB40000336061	58/56	50/50	3	95	60	30	15	0,047	20	160	1600	20	5.34 €
PB40000336063	78/63	70/60	3	100	60	30	15	0,064	20	160	960	20	6.14 €

Abraçadeira de compressão

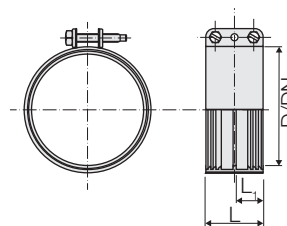

COD.	D	DN	L ₁	L	kg				QMM	€/un
PB40000271005	58	50	20,5	44	0,136	20	320	1600	20	9.88 €
PB40000271007	78	70	22,5	48	0,155	20	160	800	20	8.68 €
PB40000271011	110	100	25,5	55	0,216	20	160	640	20	8.68 €
PB40000271013	135	125	28	60	0,272	10	80	400	10	15.28 €
PB40000271015	160	150	30	65	0,359	10	80	400	10	20.91 €

União de ligação tubo de ferro

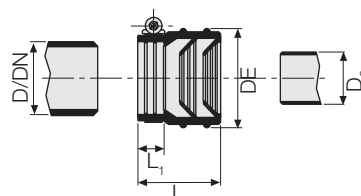

COD.	D	DN	D ₂	DE	L ₁	L	kg		QMM	€/un
PB40000272005	58	50	40/56	77	20	63	0,142	20	20	6.66 €
PB40000272007	78	70	56/75	97	20	77	0,213	20	20	8.57 €
PB40000272011	110	100	104/110	133	20	95	0,305	20	20	13.86 €



PEAD: sistemas de drenagem em polietileno de alta densidade soldável

A VERSATILIDADE DE UM SISTEMA EM POLIETILENO DE ALTA DENSIDADE PARA A DRENAGEM

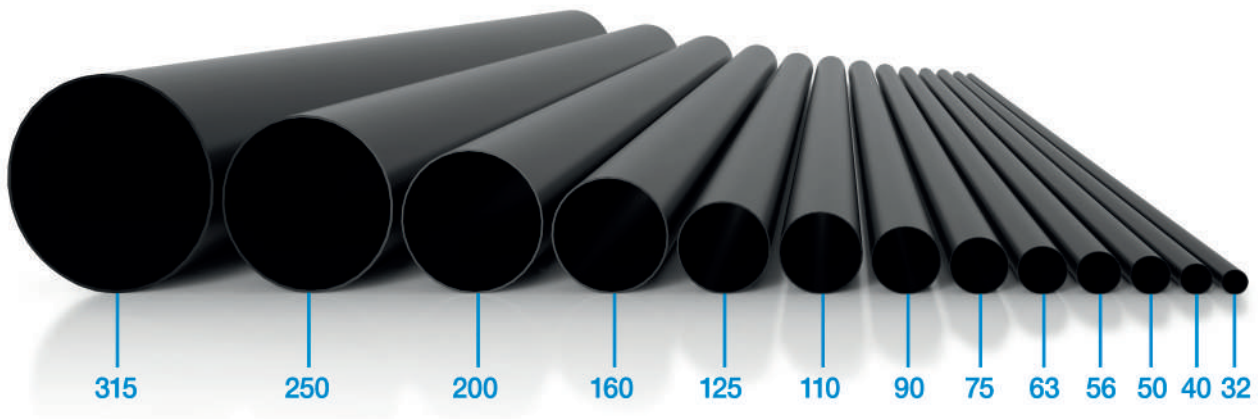

Valsir PEAD é um sistema de soldadura composto por tubos e acessórios ideal para qualquer tipologia de instalação destinada à drenagem residual ou pluvial.

Valsir PEAD é a solução ideal para a instalação quer seja no exterior, graças a sua resistência aos raios UV; quer seja enterrada ou embutida em argamassa, graças às suas excepcionais características mecânicas.



GAMA PEAD



Possibilidade de utilização completa do tubo sem gerar qualquer tipo de desperdício.



Vasta GAMA de peças especiais que permitem a realização de qualquer tipo de sistema de drenagem.



Elevada resistência das uniões graças à soldadura dos elementos.



Possibilidade de realizar peças especiais para aplicações e soluções particulares.



Material dúctil caracterizado por uma elevada resistência a baixa temperatura.



Elevada resistência química às substâncias presentes nas descargas civis e industriais.



Resistência a descargas descontínuas com temperatura até 95°C.



O produto, a sua reciclabilidade e os processos produtivos são baseados nos princípios do Green Building.



Possibilidade de pré-fabricação para reduzir os tempos de montagem “in-situ”

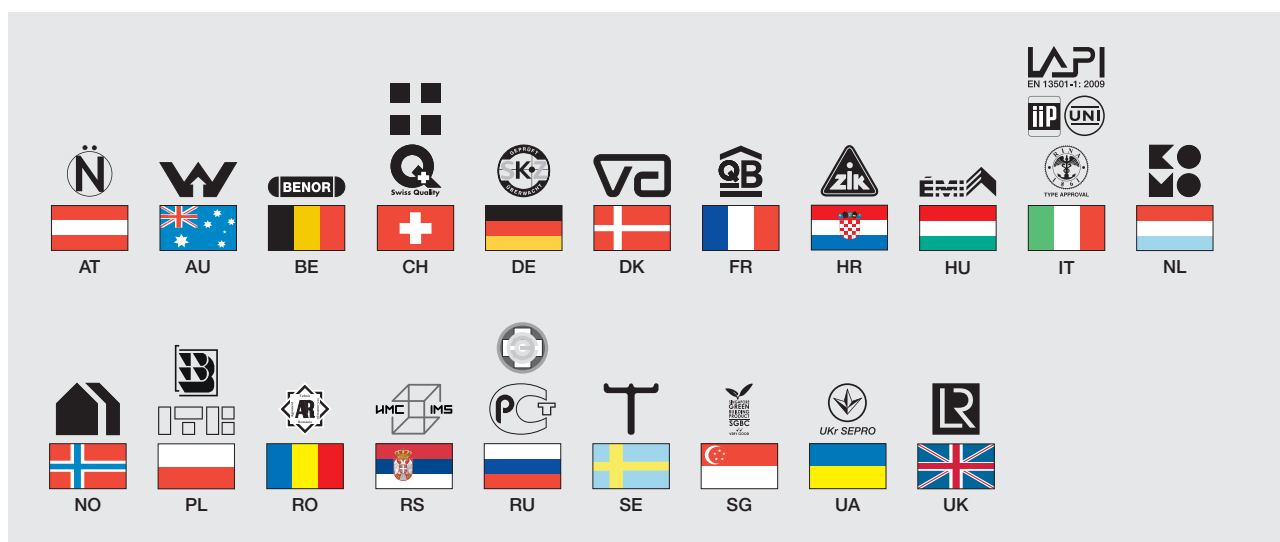

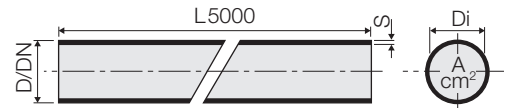
**Tubo HDPE
L 5000 mm**

COD.	D	DN	Di	S	SDR	Serie	A cm ²	PN	kg/m		QMM	€/un
PB20000300001	32	30	26	3	26/33	12,5/16	5,3	10	0,288	310	1	12.09 €
PB20000300003	40	40	34	3	26/33	12,5/16	9	8	0,374	550	1	13.74 €
PB20000300005	50	50	44	3	26/33	12,5/16	15,2	6,4	0,467	430	1	16.99 €
PB20000300006	56	56	50	3	26/33	12,5/16	19,6	5,7	0,529	490	1	20.55 €
PB20000300007	63	60	57	3	26/33	12,5/16	25,4	5	0,593	330	1	22.09 €
PB20000300009	75	70	69	3	26/33	12,5/16	37,3	4,1	0,726	290	1	26.49 €
PB20000300011	90	90	83	3,5	26	12,5	54,1	4	1,018	290	1	36.79 €
PB20000300013	110	100	101,4	4,3	26	12,5	80,7	4	1,470	285	1	54.93 €
PB20000300015	125	125	115,2	4,9	26	12,5	104,5	4	1,885	170	1	70.59 €
PB20000300017	160	150	147,6	6,2	26	12,5	171,1	4	3,080	50	1	116.41 €
PB20000300019	200	200	187,6	6,2	33	16	276,4	3,2	3,806	50	1	147.82 €
PB20000300021	250	250	234,4	7,8	33	16	431,5	3,2	5,808	40	1	230.07 €
PB20000300023	315	300	295,4	9,8	33	16	685,3	3,2	9,560	30	1	351.04 €

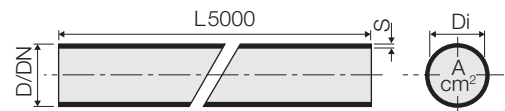

**Tubo HDPE
L 5000 mm, SDR 26**

COD.	D	DN	Di	S	A cm ²	PN	kg/m		QMM	€/un
PB20000300119	200	200	184,60	7,7	267,50	4	4,800	70	1	180.72 €
PB20000300121	250	250	230,80	9,6	418,16	4	7,618	55	1	284.33 €
PB20000300123	315	315	290,80	12,1	663,83	4	12,300	30	1	422.23 €

GAMA PEAD

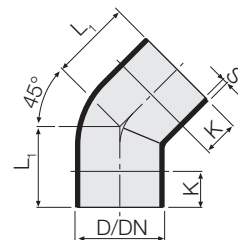

Curva 45°

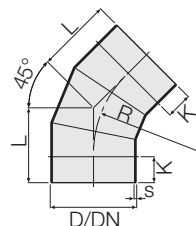

COD.	D	DN	S	L ₁	K	kg				QMM	€/un
PB20000306001	32	30	3	37	20	0,022	50	400	4000	50	1.54 €
PB20000306003	40	40	3	45	20	0,032	50	400	2400	1	1.63 €
PB20000306005	50	50	3	45	20	0,041	40	320	1920	1	1.72 €
PB20000306006	56	56	3	45	20	0,047	30	240	1440	1	2.37 €
PB20000306007	63	60	3	50	20	0,058	40	320	1600	1	2.46 €
PB20000306009	75	70	3	50	20	0,070	25	200	1000	1	3.89 €
PB20000306011	90	90	3,5	55	20	0,113	20	160	480	1	6.15 €
PB20000306013	110	100	4,3	60	25	0,175	25	100	400	1	6.61 €
PB20000306015	125	125	4,9	65	25	0,244	15	60	240	1	8.15 €
PB20000306017	160	150	6,2	69	20	0,428	1	-	160	1	17.47 €

Curva 45° raio longo





COD.	D	DN	S	L	R	K	kg				QMM	€/un
PB20000306019 *	200	200	6,2	217	230	125	1,611	1	-	32	1	45.38 €
PB20000306021 *	250	250	7,8	231	270	125	2,674	1	-	18	1	73.35 €
PB20000306023*	315	300	9,8	249	325	125	4,628	1	-	10	1	88.50 €

* Segmentada.

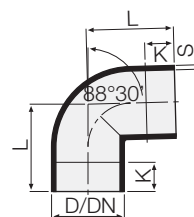

Curva 88°30'

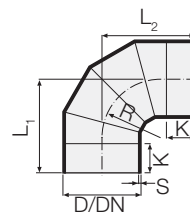

COD.	D	DN	S	L	K	kg				QMM	€/un
PB20000304000	32	30	3	48	20	0,027	50	400	4000	50	1.54 €
PB20000304001	40	40	3	50	20	0,034	50	400	2400	1	1.63 €
PB20000304003	50	50	3	60	20	0,051	30	240	1440	1	1.73 €
PB20000304004	56	56	3	65	20	0,058	30	240	1440	1	2.37 €
PB20000304005	63	60	3	70	20	0,074	30	240	1200	1	2.46 €
PB20000304007	75	70	3	75	20	0,095	20	160	800	1	4.02 €
PB20000304009	90	90	3,5	80	20	0,132	15	120	600	1	6.14 €
PB20000304011	110	100	4,3	95	25	0,232	20	80	320	1	6.77 €
PB20000304013	125	125	4,8	102	35	0,355	15	60	180	1	15.17 €
PB20000304015	160	150	6,2	123	35	0,684	1	-	90	1	34.56 €

Curva 90° raio longo





COD.	D	DN	S	L ₁	L ₂	R	K	kg			QMM	€/un
PB20000302019	200	200	6,2	248	248	175	75	1,895	1	25	1	80.59 €
PB20000302021	250	250	7,8	324	324	230	100	3,242	1	14	1	164.79 €
PB20000302023	315	300	9,8	348	348	245	105	5,693	1	7	1	232.03 €

GAMA PEAD

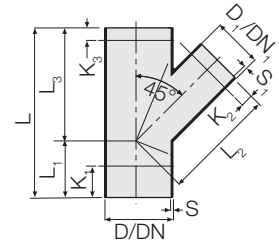
Forquilha de redução 45°



COD.	D/D ₁	DN/DN ₁	S	S ₁	L	L ₁	L ₂	L ₃	K ₁	K ₂	K ₃	kg				QMM	€/un
PB20000310001	40/32	40/30	3	3	135	45	90	-	25	30	30	0,061	50	400	2000	50	3.24 €
PB20000310003	50/40	50/40	3	3	165	55	110	-	40	45	45	0,097	20	160	960	1	3.56 €
PB20000310004	56/50	56/50	3	3	180	60	120	-	40	30	30	0,126	20	160	800	1	4.30 €
PB20000310005	63/40	60/40	3	3	195	65	130	-	40	30	30	0,136	20	120	600	1	4.61 €
PB20000310007	63/50	60/50	3	3	195	65	130	-	40	30	30	0,151	15	120	600	1	4.61 €
PB20000310008	63/56	60/56	3	3	195	65	130	-	40	25	25	0,146	15	120	600	1	4.61 €
PB20000310009	75/40	70/40	3	3	210	70	140	-	60	30	40	0,181	15	100	400	1	5.52 €
PB20000310011	75/50	70/50	3	3	210	70	140	-	60	30	40	0,184	25	100	400	1	5.52 €
PB20000310012	75/56	70/56	3	3	210	70	140	-	55	25	35	0,181	25	100	400	1	5.52 €
PB20000310014	75/63	70/60	3	3	210	70	140	-	55	25	35	0,189	25	100	400	1	7.19 €
PB20000310013	90/40	90/40	3,5	3	240	80	160	-	80	40	50	0,261	25	60	240	1	8.38 €
PB20000310015	90/50	90/50	3,5	3	240	80	160	-	80	40	50	0,267	15	60	240	1	7.19 €
PB20000310006	90/56	90/56	3,5	3	240	80	160	-	75	35	45	0,279	15	80	320	1	6.70 €
PB20000310018	90/63	90/60	3,5	3	240	80	160	-	65	30	25	0,281	20	60	240	1	10.55 €
PB20000310010	90/75	90/70	3,5	3	240	80	160	-	65	30	25	0,285	15	60	240	1	10.55 €
PB20000310017	110/40	100/40	4,3	3	270	90	180	-	95	50	55	0,441	15	40	160	1	9.00 €
PB20000310019	110/50	100/50	4,3	3	270	90	180	-	95	50	55	0,432	10	40	160	1	9.00 €
PB20000310020	110/56	100/56	4,3	3	270	90	180	-	90	40	45	0,447	10	40	160	1	9.00 €
PB20000310021	110/63	100/60	4,3	3	270	90	180	-	80	35	40	0,448	10	40	160	1	9.00 €
PB20000310023	110/75	100/70	4,3	3	270	90	180	-	75	30	35	0,471	10	40	160	1	9.00 €
PB20000310025	110/90	100/90	4,3	3,5	270	90	180	-	65	25	30	0,493	10	40	160	1	9.00 €
PB20000310027	125/40	125/40	4,9	3	300	100	200	-	95	45	50	0,612	10	40	120	1	10.05 €
PB20000310029	125/50	125/50	4,9	3	300	100	200	-	95	45	50	0,620	10	40	120	1	10.05 €
PB20000310030	125/56	125/56	4,9	3	300	100	200	-	95	45	50	0,618	10	40	80	1	10.05 €
PB20000310031	125/63	125/60	4,9	3	300	100	200	-	95	40	50	0,630	10	40	120	1	10.05 €
PB20000310033	125/75	125/70	4,9	3	300	100	200	-	95	40	50	0,635	10	40	120	1	10.05 €
PB20000310035	125/90	125/90	4,9	3,5	300	100	200	-	80	35	30	0,648	10	40	80	1	10.05 €
PB20000310037	125/110	125/100	4,9	4,3	300	100	200	-	70	25	25	0,698	10	40	80	1	10.05 €
PB20000310067 *	160/40	150/40	6,2	3	375	125	250	-	150	90	120	1,197	10	-	50	1	59.59 €
PB20000310068 *	160/50	150/50	6,2	3	375	125	250	-	150	90	110	1,196	1	-	50	1	59.59 €
PB20000310069 *	160/56	150/56	6,2	3	375	125	250	-	145	90	110	1,212	1	-	50	1	59.59 €
PB20000310070	160/63	150/60	6,2	3	375	125	250	-	140	85	105	1,194	1	-	50	1	41.18 €
PB20000310071	160/75	150/70	6,2	3	375	125	250	-	130	80	100	1,223	1	-	50	1	59.59 €
PB20000310072	160/90	150/90	6,2	3,5	375	125	250	-	120	70	90	1,272	1	-	50	1	61.92 €
PB20000310039	160/110	150/100	6,2	4,3	375	125	250	-	110	45	55	1,259	1	-	50	1	61.92 €
PB20000310041	160/125	150/125	6,2	4,9	375	125	250	-	100	40	50	1,312	1	-	45	1	41.18 €
PB20000310074 *	200/40	200/40	6,2	3	490	180	360	310	232	180	160	1,951	1	-	25	1	88.44 €
PB20000310075 *	200/50	200/50	6,2	3	490	180	360	310	225	175	155	1,997	1	-	20	1	88.44 €
PB20000310076 *	200/56	200/56	6,2	3	490	180	360	310	220	170	150	1,994	1	-	25	1	88.44 €

COD.	D/D ₁	DN/DN ₁	S	S ₁	L	L ₁	L ₂	L ₃	K ₁	K ₂	K ₃	kg				QMM	€/un
PB20000310077 *	200/63	200/60	6,2	3	490	180	360	310	215	170	145	2,032	1	-	25	1	88.44 €
PB20000310078 *	200/75	200/70	6,2	3	540	180	360	360	210	160	185	2,246	1	-	20	1	92.33 €
PB20000310079 *	200/90	200/90	6,2	3,5	540	180	360	360	200	155	175	2,328	1	-	20	1	92.33 €
PB20000310043 *	200/110	200/100	6,2	4,3	540	180	360	-	150	140	65	2,352	1	-	20	1	86.48 €
PB20000310045 *	200/125	200/125	6,2	4,9	540	180	360	-	140	130	55	2,414	1	-	20	1	87.75 €
PB20000310047 *	200/160	200/150	6,2	6,2	540	180	360	-	115	85	35	2,615	1	-	18	1	92.49 €
PB20000310081 *	250/40	250/40	7,7	3	660	220	400	440	300	185	270	3,945	1	-	10	1	120.86 €
PB20000310082 *	250/50	250/50	7,7	3	660	220	400	440	290	180	260	4,027	1	-	10	1	120.86 €
PB20000310083 *	250/56	250/56	7,7	3	660	220	400	440	285	175	255	4,019	1	-	10	1	120.86 €
PB20000310084 *	250/63	250/60	7,7	3	660	220	400	440	280	175	250	3,992	1	-	10	1	120.86 €
PB20000310085 *	250/75	250/70	7,7	3	660	220	400	440	275	165	245	3,998	1	-	10	1	127.24 €
PB20000310086 *	250/90	250/90	7,7	3,5	660	220	400	440	265	160	235	4,143	1	-	10	1	127.24 €
PB20000310049 *	250/110	250/100	7,8	4,3	660	220	440	-	215	185	150	4,215	1	-	10	1	125.40 €
PB20000310051 *	250/125	250/125	7,8	4,9	660	220	440	-	205	175	140	4,283	1	-	10	1	125.40 €
PB20000310053 *	250/160	250/150	7,8	6,2	660	220	440	-	180	130	50	4,594	1	-	10	1	132.18 €
PB20000310055 *	250/200	250/200	7,8	6,2	660	220	440	-	150	50	90	4,759	1	-	10	1	140.05 €
PB20000310088 *	315/40	300/40	9,7	3	840	280	500	560	390	240	355	8,570	1	-	-	1	166.87 €
PB20000310089 *	315/50	300/50	9,7	3	840	280	500	560	385	235	350	7,948	1	-	6	1	166.87 €
PB20000310090 *	315/56	300/56	9,7	3	840	280	500	560	380	235	345	8,570	1	-	-	1	166.87 €
PB20000310091 *	315/63	315/60	9,7	3	840	280	500	560	375	225	340	7,941	1	-	5	1	166.87 €
PB20000310092 *	315/75	300/70	9,7	3	840	280	500	560	365	220	330	8,012	1	-	5	1	166.87 €
PB20000310093 *	315/90	300/90	9,7	3,5	840	280	500	560	355	215	320	8,100	1	-	5	1	166.87 €
PB20000310057 *	315/110	300/100	9,8	4,3	840	280	560	-	305	260	235	8,273	1	-	4	1	166.87 €
PB20000310059 *	315/125	300/125	9,8	4,9	840	280	560	-	290	250	220	8,345	1	-	4	1	166.87 €
PB20000310061 *	315/160	300/150	9,8	6,2	840	280	560	-	270	205	200	8,768	1	-	4	1	170.23 €
PB20000310063 *	315/200	300/200	9,8	6,2	840	280	560	-	240	125	175	8,849	1	-	4	1	175.29 €
PB20000310065 *	315/250	300/250	9,8	7,8	840	280	560	-	205	130	140	9,359	1	-	4	1	185.41 €

* Derivação soldada.

GAMA PEAD

Forquilha 45°

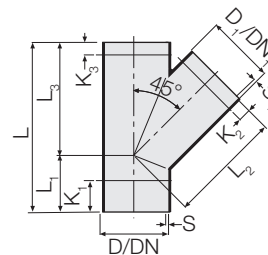

COD.	D/D ₁	DN/DN ₁	S/S ₁	L	L ₁	L ₂ /L ₃	K ₁	K ₂	K ₃	kg				QMM	€/un
PB20000309001	32	30	3	110	35	75	20	20	20	0,044	50	400	2400	50	3.04 €
PB20000309003	40	40	3	135	45	90	25	30	30	0,069	50	400	2000	1	3.24 €
PB20000309005	50	50	3	165	55	110	35	20	20	0,105	20	160	960	1	3.56 €
PB20000309006	56	56	3	180	60	120	40	25	25	0,124	20	160	800	1	4.30 €
PB20000309007	63	60	3	195	65	130	40	25	25	0,151	15	120	600	1	4.87 €
PB20000309009	75	70	3	210	70	140	40	25	25	0,190	20	80	320	1	5.52 €
PB20000309011	90	90	3,5	240	80	160	50	20	20	0,312	15	60	240	1	7.19 €
PB20000309013	110	100	4,3	270	90	180	55	20	20	0,491	10	40	120	1	8.99 €
PB20000309015	125	125	4,9	300	100	200	60	20	20	0,773	10	40	80	1	10.71 €
PB20000309017	160	150	6,2	375	125	250	75	25	25	1,479	1	-	45	1	41.18 €
PB20000309019 *	200	200	6,2	540	180	360	85	10	10	2,811	1	-	16	1	98.45 €
PB20000309021 *	250	250	7,8	660	220	440	115	55	55	5,166	1	-	8	1	153.41 €
PB20000309023 *	315	300	9,8	840	280	560	160	95	95	10,254	1	-	3	1	205.87 €

* Derivação soldada.

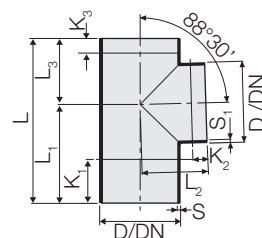

Forquilha 88°30'

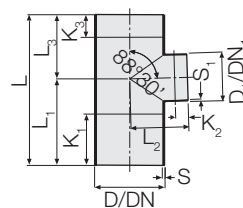

COD.	D/D ₁	DN/DN ₁	S/S ₁	L	L ₁	L ₂ /L ₃	K ₁	K ₂	K ₃	kg				QMM	€/un
PB20000312003	40	40	3	130	75	55	45	20	20	0,057	50	400	2000	50	3.24 €
PB20000312005	50	50	3	150	90	60	55	25	25	0,081	30	240	1200	30	3.56 €
PB20000312006	56	56	3	175	105	70	65	30	30	0,109	25	200	600	25	4.30 €
PB20000312007	63	60	3	175	105	70	60	25	25	0,124	20	160	800	20	4.61 €
PB20000312009	75	70	3	175	105	70	55	25	25	0,146	15	120	600	15	5.52 €
PB20000312011	90	90	3,5	200	120	80	65	25	25	0,132	20	80	320	20	7.19 €
PB20000312013	110	100	4,3	225	135	90	65	20	20	0,361	15	60	240	15	9.00 €
PB20000312015	125	125	4,9	250	150	100	70	20	20	0,502	15	60	120	15	10.05 €
PB20000312017	160	150	6,2	350	210	140	105	30	30	1,175	1	-	50	1	41.18 €
PB20000312019*	200	200	6,2	360	180	180	25	30	25	1,631	1	-	25	1	73.08 €
PB20000312021*	250	250	7,8	440	220	220	40	40	40	3,064	1	-	15	1	104.95 €
PB20000312023*	315	300	9,8	560	280	280	70	65	70	6,198	1	-	5	1	136.07 €

* Derivação soldada.

**Forquilha de redução
88°30'**

COD.	D/D ₁	DN/DN ₁	S	S ₁	L	L ₁	L ₂ /L ₃	K ₁	K ₂	K ₃	kg				QMM	€/un
PB20000313001	40/32	40/30	3	3	130	75	55	50	20	25	0,052	50	400	2000	50	3.24 €
PB20000313003	50/40	50/40	3	3	150	90	60	60	25	30	0,080	25	200	1200	25	3.56 €
PB20000313002	56/50	56/50	3	3	175	105	70	70	30	35	0,107	25	200	600	25	4.28 €
PB20000313008	63/40	60/40	3	3	175	105	70	70	30	35	0,116	20	160	800	20	5.90 €
PB20000313012	63/50	60/50	3	3	175	105	70	70	30	35	0,122	20	160	480	20	5.90 €
PB20000313004	75/40	70/40	3	3	175	105	70	75	25	35	0,139	25	100	400	25	5.52 €
PB20000313005	75/50	70/50	3	3	175	105	70	70	25	35	0,141	20	160	480	20	5.52 €
PB20000313006	75/56	70/56	3	3	175	105	70	65	25	30	0,141	20	160	480	20	5.52 €
PB20000313010	75/63	70/60	3	3	175	105	70	60	25	25	0,143	20	160	480	20	5.52 €
PB20000313007	90/40	90/40	3,5	3	200	120	80	85	25	45	0,202	20	80	320	20	7.19 €
PB20000313009	90/50	90/50	3,5	3	200	120	80	85	25	45	0,205	20	80	320	20	7.19 €
PB20000313034	90/56	90/56	3,5	3	200	120	80	85	25	35	0,206	20	80	320	20	19.32 €
PB20000313028	90/63	90/60	3,5	3	200	120	80	75	25	35	0,203	20	80	320	20	19.32 €
PB20000313036	90/75	90/70	3,5	3	200	120	80	70	25	30	0,210	20	80	320	20	19.32 €
PB20000313011	110/40	100/40	4,3	3	225	135	90	100	25	60	0,336	15	60	240	15	9.00 €
PB20000313013	110/50	100/50	4,3	3	225	135	90	95	25	50	0,336	15	60	240	15	9.00 €
PB20000313014	110/56	100/56	4,3	3	225	135	90	90	25	45	0,340	15	60	240	15	9.00 €
PB20000313015	110/63	100/60	4,3	3	225	135	90	95	25	35	0,337	15	60	240	15	9.00 €
PB20000313017	110/75	100/70	4,3	3	225	135	90	85	25	35	0,340	15	60	240	15	9.00 €
PB20000313019	110/90	100/90	4,3	3,5	225	135	90	75	25	30	0,347	15	60	240	15	9.00 €
PB20000313021	125/110	125/100	4,9	4,3	250	150	100	80	20	30	0,476	15	60	120	15	10.05 €
PB20000313022 *	160/75	150/70	6,2	3	350	210	140	150	25	70	1,210	1	-	55	1	46.44 €
PB20000313023	160/110	150/100	6,2	4,3	350	210	140	135	45	60	1,112	1	-	55	1	41.18 €
PB20000313025	160/125	150/125	6,2	4,9	350	210	140	125	45	50	1,128	1	-	60	1	41.18 €
PB20000313027 *	200/110	200/100	6,2	4,3	360	180	180	70	60	70	1,537	1	-	30	1	70.24 €
PB20000313029 *	200/125	200/125	6,2	4,9	360	180	180	65	60	65	1,514	1	-	30	1	70.24 €
PB20000313031 *	200/160	200/150	6,2	6,2	360	180	180	45	50	45	1,586	1	-	30	1	71.92 €
PB20000313033 *	250/110	250/100	7,8	4,3	440	220	220	110	75	110	2,689	1	-	20	1	98.19 €
PB20000313035 *	250/125	250/125	7,8	4,9	440	220	220	105	75	105	2,743	1	-	20	1	98.19 €
PB20000313037 *	250/160	250/150	7,8	6,2	440	220	220	85	65	85	2,798	1	-	20	1	100.56 €
PB20000313039 *	250/200	250/200	7,8	6,2	440	220	220	65	60	65	2,963	1	-	15	1	102.00 €
PB20000313041 *	315/110	300/100	9,8	4,3	560	280	280	170	100	170	5,431	1	-	11	1	126.14 €
PB20000313043 *	315/125	300/125	9,8	4,9	560	280	280	165	100	165	5,271	1	-	10	1	126.85 €
PB20000313045 *	315/160	300/150	9,8	6,2	560	280	280	145	90	145	5,714	1	-	7	1	128.62 €
PB20000313047 *	315/200	300/200	9,8	6,2	560	280	280	120	65	120	5,709	1	-	5	1	130.32 €
PB20000313049 *	315/250	300/250	9,8	7,8	560	280	280	95	65	95	5,863	1	-	9	1	133.80 €

* Derivação soldada.

GAMA PEAD

VBF
Forquilha
misturadora

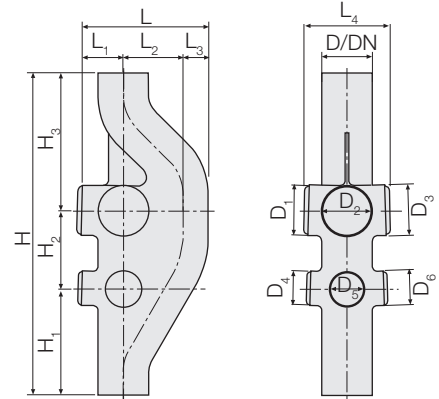

COD.	D	DN	D _{1/2/3}	D _{4/5/6}	L	L ₁	L ₂	L ₃	L ₄	H	H ₁	H ₂	H ₃	kg		QMM	€/un
PB20000316175	110	100	110	75	275	90	130	55	188	700	230	170	300	2,855	1	1	66.12 €
PB20000316179	160	150	110	75	310	90	160	60	190	1010	460	170	380	5,139	1	1	246.93 €

Forquilha de
inspeção com tampa
roscada

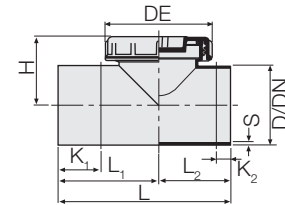

COD.	D	DN	S	L	L ₁	L ₂	H	DE	K ₁	K ₂	kg				QMM	€/un
PB20000348001 *	40	40	3	130	75	55	69	60	45	20	0,105	20	160	960	20	11.43 €
PB20000348003 *	50	50	3	150	90	60	75	70	55	25	0,131	20	160	800	20	11.43 €
PB20000348004	56	56	3	175	105	70	84	85	65	30	0,194	20	160	480	1	11.93 €
PB20000348005 *	63	60	3	175	100	75	80	90	60	25	0,220	15	120	600	1	12.65 €
PB20000348007 *	75	70	3	175	105	70	117	109	55	25	0,358	10	80	240	1	14.76 €
PB20000348009 *	90	90	3,5	200	120	80	125	128	65	25	0,518	10	40	160	1	19.82 €
PB20000348011	110	100	4,3	240	140	100	94	149*	65	20	0,545	10	40	160	1	21.27 €
PB20000348013	125	125	4,9	250	150	100	124	149*	70	20	0,675	5	20	80	1	25.01 €
PB20000348015	160	150	6,2	350	210	140	145	149*	105	30	1,239	1	-	54	1	53.78 €
PB20000348017 *	200	200	6,2	360	180	180	165	149*	180	25	1,633	1	-	30	1	104.15 €
PB20000348019 *	250	250	7,8	440	220	220	190	149*	220	40	2,800	1	-	15	1	119.59 €
PB20000348021 *	315	300	9,8	560	280	280	225	149*	280	70	5,578	1	-	8	1	150.30 €

* Derivação soldada.

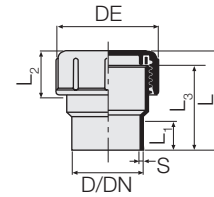
Tampão de fecho completo

COD.	D	DN	s	L	L ₁	L ₂	L ₃	DE	kg				QMM	€/un
PB20000340001	40	40	3	75	30	34	66	60	0,066	40	320	1920	40	4.38 €
PB20000340003	50	50	3	75	30	33	66	70	0,073	40	320	1920	40	4.67 €
PB20000340004	56	56	3	77	30	34	66	85	0,117	20	160	960	20	5.31 €
PB20000340005	63	60	3	76	30	43	66	90	0,131	20	160	960	20	6.89 €
PB20000340007	75	70	3	103	30	45	87	109	0,248	20	160	480	20	8.20 €
PB20000340009	90	90	3,5	103	30	46	88	128	0,345	15	120	360	15	12.18 €
PB20000340011	110	100	4,3	106	30	65	89	144	0,503	10	80	240	10	13.22 €

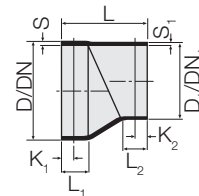
Redução excêntrica série longa

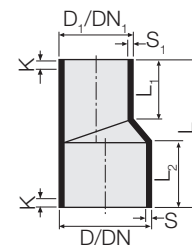

COD.	D/D ₁	DN/DN ₁	S	S ₁	L	L ₁	L ₂	K ₁	K ₂	kg				QMM	€/un
PB20000358041 *	160/110	150/100	6,2	4,3	215	35	37	20	20	0,472	5	40	120	5	47.28 €
PB20000358043	160/125	150/125	6,2	4,9	140	45	40	20	20	0,334	5	40	240	5	47.28 €
PB20000358045 *	200/110	200/100	6,2	4,3	285	80	40	50	10	0,942	1	-	90	1	55.85 €
PB20000358047 *	200/125	200/125	6,2	4,9	285	80	40	50	10	0,922	1	-	90	1	55.85 €
PB20000358049	200/160	200/150	6,2	6,2	210	80	37	50	10	0,720	1	-	126	1	34.89 €
PB20000358055 *	250/200	250/200	7,8	6,2	405	160	140	100	100	1,942	1	-	40	1	72.58 €
PB20000358061 *	315/200	300/200	9,8	6,2	540	160	140	100	100	3,400	1	-	15	1	114.67 €
PB20000358063 *	315/250	300/250	9,8	7,8	450	160	150	100	100	3,346	1	-	16	1	114.67 €

* Derivação soldada.

Redução excêntrica série curta



COD.	D/D ₁	DN/DN ₁	S	S ₁	L	L ₁	L ₂	K	kg				QMM	€/un
PB20000358001	50/40	50/40	3	3	80	35	35	20	0,033	50	400	4000	1	1.28 €
PB20000358002	56/50	56/50	3	3	80	37	35	20	0,038	30	240	2400	1	1.34 €
PB20000358003	63/40	60/40	3	3	80	37	35	20	0,039	30	240	2400	1	1.57 €
PB20000358005	63/50	60/50	3	3	80	37	35	20	0,041	30	240	2400	1	1.57 €
PB20000358006	63/56	60/56	3	3	80	40	35	20	0,043	30	240	2400	1	1.66 €

GAMA PEAD

COD.	D/D ₁	DN/DN ₁	S	S ₁	L	L ₁	L ₂	K	kg				QMM	€/un
PB20000358007	75/40	70/40	3	3	80	37	35	20	0,047	30	240	1440	1	1.78 €
PB20000358009	75/50	70/50	3	3	80	37	35	20	0,050	30	240	1440	1	1.78 €
PB20000358010	75/56	70/56	3	3	80	37	35	20	0,052	30	240	1440	1	1.95 €
PB20000358011	75/63	70/60	3	3	80	35	35	20	0,052	30	240	1440	1	1.97 €
PB20000358013	90/40	90/40	3,5	3	80	37	35	20	0,067	30	240	1440	1	2.61 €
PB20000358015	90/50	90/50	3,5	3	80	37	35	20	0,068	30	240	1440	1	2.39 €
PB20000358016	90/56	90/56	3,5	3	80	37	35	20	0,071	25	200	1200	1	2.39 €
PB20000358017	90/63	90/60	3,5	3	80	37	35	20	0,068	25	200	1200	1	2.39 €
PB20000358019	90/75	90/70	3,5	3	80	37	35	20	0,070	25	200	1200	1	2.39 €
PB20000358021	110/40	100/40	4,3	3	80	37	35	20	0,094	25	200	1000	1	2.92 €
PB20000358023	110/50	100/50	4,3	3	80	37	35	20	0,098	25	200	1000	1	2.92 €
PB20000358024	110/56	100/56	4,3	3	80	37	35	20	0,096	25	200	1000	1	2.92 €
PB20000358025	110/63	100/60	4,3	3	80	37	35	20	0,100	25	200	1000	1	2.92 €
PB20000358027	110/75	100/70	4,3	3	80	37	35	20	0,098	25	200	1000	1	2.92 €
PB20000358029	110/90	100/90	4,3	3,5	80	37	35	20	0,105	25	200	1000	1	2.92 €
PB20000358031	125/50	125/50	4,9	3	80	37	35	20	0,125	10	80	480	1	4.81 €
PB20000358032	125/56	125/56	4,9	3	80	37	35	20	0,121	10	80	480	1	4.81 €
PB20000358033	125/63	125/60	4,9	3	80	37	35	20	0,123	10	80	480	1	4.81 €
PB20000358035	125/75	125/70	4,9	3	80	37	35	20	0,126	10	80	480	1	4.81 €
PB20000358037	125/90	125/90	4,9	3,5	80	37	35	20	0,126	10	80	480	1	4.81 €
PB20000358039	125/110	125/100	4,9	4,3	80	37	35	20	0,118	10	80	480	1	10.97 €
PB20000358038	160/110	150/100	6,2	4,3	80	37	35	20	0,225	5	40	240	1	10.97 €
PB20000358040	160/125	150/125	6,2	4,9	80	37	35	20	0,213	5	40	240	1	10.97 €

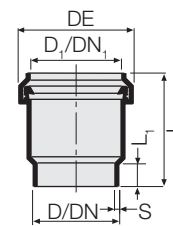
União com tampão



COD.	D/D ₁	DN/DN ₁	s	DE	L	L ₁	kg				QMM	€/un
PB20000324000	32	30	3	46	46	8	0,026	100	800	4800	100	2.61 €
PB20000324001	40	40	3	56,5	65	13	0,043	50	400	2400	50	2.78 €
PB20000324003	50	50	3	66,5	65	13	0,054	50	400	2400	50	3.19 €
PB20000324004	56	56	3	72,5	65	13	0,064	30	240	1440	30	3.89 €
PB20000324005	63	60	3	79	65	11	0,077	30	240	1440	30	4.10 €
PB20000324006	63/56	60/56	3	72,5	50	-	0,050	40	320	1920	40	4.10 €
PB20000324007	75	70	3	92	90	17	0,110	30	240	1200	30	5.04 €
PB20000324009	90	90	3,5	108	90	17	0,148	25	200	600	25	6.40 €
PB20000324011	110	100	4,3	130	95	17	0,221	10	80	400	10	7.43 €
PB20000324013	125	125	4,9	149	95	15	0,278	10	80	400	10	9.72 €
PB20000324015	160	150	6,2	188	130	30	0,656	1	-	165	1	21.17 €
PB20000324017	200	200	6,2	225	170	18	1,390	1	-	50	1	104.29 €
PB20000324019 *	250	250	7,8	278	170	22	2,274	1	-	33	1	165.12 €
PB20000324021 *	315	300	9,8	350	180	22	3,782	1	-	18	1	197.55 €

* Sem tampão.

União eletrossoldável

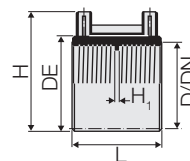

COD.	D	DN	L	DE	H	H ₁	kg				QMM	€/un
PB20000350001	40	40	64	52	68	3	0,053	10	240	3360	1	5.34 €
PB20000350003	50	50	60	63	80	3	0,065	10	190	2850	1	5.75 €
PB20000350004	56	56	60	70	86	3	0,078	10	160	2400	1	6.82 €
PB20000350005	63	60	60	77	92	3	0,080	10	140	1960	1	6.91 €
PB20000350007	75	70	60	90	105	3	0,101	10	480	1440	1	7.85 €
PB20000350009	90	90	60	106	121	3	0,126	10	350	1050	1	8.73 €
PB20000350011	110	100	60	126	143	3	0,161	10	270	810	1	9.95 €
PB20000350013	125	125	60	142	158	3	0,213	5	200	600	1	11.27 €
PB20000350015	160	150	60	178	194	3	0,286	5	120	360	1	18.85 €
PB20000350117	200	200	153	233	248	3	1,399	1	-	75	1	110.85 €
PB20000350119	250	250	153	285	300	3	1,786	1	-	55	1	147.80 €
PB20000350121	315	300	153	350	365	3	2,598	1	-	34	1	184.74 €

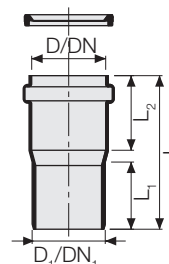
Adaptador de ligação
ao PVC

COD.	D/D ₁	DN/DN ₁	L	L ₁	L ₂	kg				QMM	€/un
PC10000564121	40/40	40/40	105	50	55	0,045	40	320	1920	40	3.60 €
PC10000564122	50/50	43/40	105	44	47	0,051	30	240	1440	30	3.96 €
PC10000564123	50/50	50/50	105	50	55	0,054	30	240	1440	30	3.70 €
PC10000564150	50/100	50/100	130	91	40	0,186	10	80	480	10	12.70 €
PC10000564075	75/75	70/70	144	87	58	0,177	15	120	480	15	7.74 €
PC10000564131	75/80	70/80	154	78	75	0,176	15	120	480	15	7.74 €
PC10000564182	75/82	70/80	159	78	80	0,197	15	120	480	15	7.74 €
PC10000564175	75/100	70/100	156	77	77	0,143	10	80	480	10	9.27 €
PC10000564190	90/100	90/100	143	76	65	0,216	10	80	320	10	8.59 €
PC10000564101	110/100	100/100	147	83	57	0,241	10	80	320	10	11.96 €
PC10000564251	110/125	100/125	145	83	60	0,290	10	80	240	10	9.02 €

ACESSÓRIOS SISTEMA DE DRENAGEM

Colar cortafogo

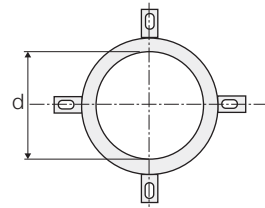

PP3 - TRIPLUS - BLACKFIRE - SILERE - HDPE

	COD.	d interno	H largura	N° fissaggi		QMM	€/un
	PC10000411051	32	50	4	5	5	30.34 €
	PC10000411053	40	50	4	5	5	31.49 €
	PC10000411055	55	50	4	5	5	31.99 €
	PC10000411057	63	50	4	5	5	36.08 €
	PC10000411059	75	50	4	5	5	38.62 €
	PC10000411061	82	50	4	5	5	39.26 €
	PC10000411063	90	50	4	5	5	44.36 €
	PC10000411065	110	50	4	10	10	49.83 €
	PC10000411067	125	60	4	5	5	75.59 €
	PC10000411069	140	60	4	1	1	89.52 €
	PC10000411071	160	60	4	10	10	101.34 €
	PC10000411073	200	75	6	1	1	323.76 €
	PC10000411075	250	75	6	1	1	418.09 €
	PC10000411077	315	75	6	1	1	558.29 €

Uma vez instalada a tubagem, é necessário que em ambos os lados da parede seja preenchida a abertura entre o tubo e a parede utilizando o vedante acrílico Tecno-S 240 (411090)

Acessórios

Selante Tecno-S 240



	COD.	Conf.		QMM	€/un
	PC10000411090	310 ml	25	25	9.00 €

Válvula admissão ar

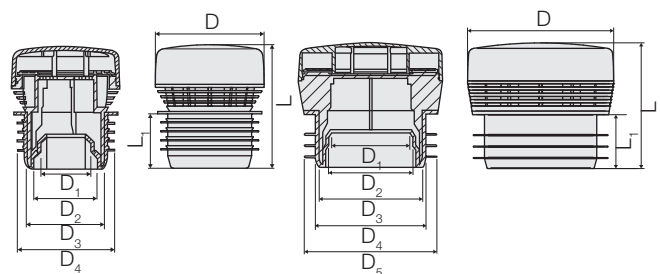

PC10000700401

PC10000700401

PP3 - TRIPLUS - BLACKFIRE - SILERE - HDPE

	COD.	D	D ₁	D ₂	D ₃	D ₄	D ₅	L	L ₁	kg		QMM	€/un
	PC10000700401	70	32	40	50	63	-	79,5	35	0,102	12	1	19.11 €
	PC10000700402	125	70	75	90	100	110	108	46	0,358	6	1	37.19 €

Colar galvanizado M10

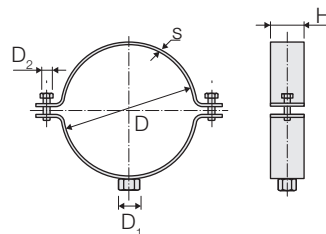

PP3 - TRIPLUS - BLACKFIRE - HDPE

COD.	D	D ₁	D ₂	H	s	kg		QMM	€/un
PB21000396021	40	M10	M6	30	2,5	0,158	50	1	4.18 €
PB21000396023	50	M10	M6	30	2,5	0,177	50	1	4.57 €
PB21000396024	56	M10	M6	30	2,5	0,184	50	1	5.04 €
PB21000396025	63	M10	M6	30	2,5	0,199	50	1	5.04 €
PB21000396027	75	M10	M6	30	2,5	0,220	25	1	5.04 €
PB21000396029	90	M10	M6	30	2,5	0,250	25	1	5.04 €
PB21000396031	110	M10	M6	30	2,5	0,286	25	1	5.04 €
PB21000396033	125	M10	M6	30	2,5	0,309	25	1	5.70 €
PB21000396035	160	M10	M6	30	2,5	0,376	25	1	6.42 €

Colar galvanizado G1"

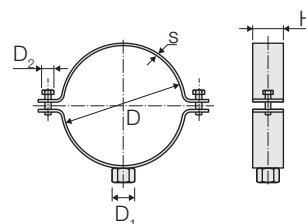

PP3 - TRIPLUS - BLACKFIRE - HDPE

COD.	D	D ₁	D ₂	H	s	kg		QMM	€/un
PB21000396050	200	G1"	M8	40	4	0,651	10	1	20.48 €
PB21000396052	250	G1"	M8	40	4	1,270	10	1	22.55 €
PB21000396054	315	G1"	M8	40	4	1,564	10	1	23.68 €

Colar galvanizado antivibração M10

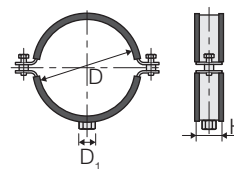

PP3 - TRIPLUS - BLACKFIRE - SILERE - HDPE

COD.	D	D ₁	H	kg		QMM	€/un
PC10000396081	40	M10	30	0,179	50	1	5.17 €
PC10000396082	50	M10	30	0,205	50	1	5.39 €
PC10000396083	56	M10	30	0,219	50	1	5.80 €
PC10000396084	58	M10	30	0,221	50	1	5.80 €
PC10000396085	63	M10	30	0,234	50	1	6.14 €
PC10000396086	75	M10	30	0,258	25	1	6.68 €

ACESSÓRIOS SISTEMA DE DRENAGEM

COD.	D	D ₁	H	kg		QMM	€/un
PC10000396087	78	M10	30	0,253	25	1	6.68 €
PC10000396088	90	M10	30	0,291	25	1	7.38 €
PC10000396089	110	M10	30	0,346	25	1	7.50 €
PC10000396090	125	M10	30	0,384	25	1	8.61 €
PC10000396091	135	M10	30	0,407	25	1	9.70 €
PC10000396092	160	M10	30	0,469	25	1	10.74 €

Colar galvanizado
antivibração G1"



PP3 - TRIPLUS - BLACKFIRE - SILERE - HDPE

COD.	D	D ₁	H	kg		QMM	€/un
PC10000396073	200	G1"	40	1,257	10	1	24.45 €
PC10000396074	250	G1"	40	1,496	10	1	28.12 €
PC10000396075	315	G1"	40	1,798	10	1	33.94 €

Flange de fixação

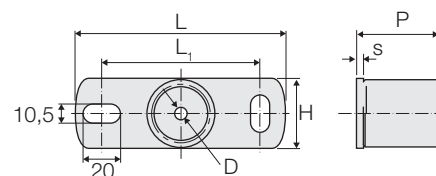

PP3 - TRIPLUS - BLACKFIRE - SILERE - HDPE

COD.	D	L	H	P	s	L ₁	kg		QMM	€/un
PB21000398005	G1"	120	40	50	4	90	0,236	25	25	7.99 €
PB21000398007	M10	80	30	13	2	52	0,060	25	25	3.48 €

Varão roscado M10

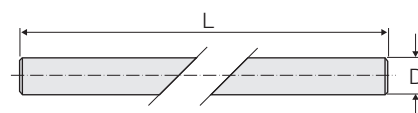
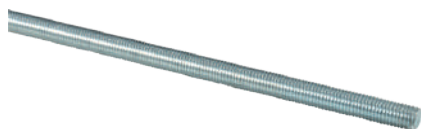

PP3 - TRIPLUS - BLACKFIRE - SILERE - HDPE

COD.	D	L	kg		QMM	€/un
PB21000408001	M10	1000	0,418	1	1	2.55 €

Isolamento termoacústico para tubos de drenagem

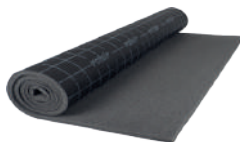

HDPE

COD.	Dimensoni LxH	s	kg	 (m ²)	QMM	€/un
PC10000399252	2000x1000	14	4,814	2	1	183.66 €

É composto por uma resina de poliuretano expandido autoextinguente de células abertas de espessura de 12 mm e densidade de 30 kg/m³, ligada a uma cama de borracha antichama de 4 kg/m³ com espessura de 2 mm. Não contém chumbo, betume ou outras substâncias nocivas.

Máquina de soldadura topo-a-topo de bancada



HDPE

COD.	D	kg		QMM	€/un
PC10000468165	40÷160	102,800	1	1	8 246.73 €

Nota: o artigos não inclui as reduções e suportes laterais para o D 56.

Isolamento termoacústico Fonoblock

HDPE

COD.	DN	cx	QMM	€/un
PB21000000301	50	15 m	1	58.46 €
PB21000000302	60	15 m	1	74.04 €
PB21000000303	70	15 m	1	78.81 €
PB21000000304	90	15 m	1	90.93 €
PB21000000305	110	15 m	1	101.32 €
PB21000000306	125	15 m	1	126.00 €
PB21000000307	160	15 m	1	165.40 €

Isolamento termoacústico Fonoblock

HDPE

COD.	L(mm)	cx	QMM	€/un
PB21000000310	50	15 m	1	37.59 €

ACESSÓRIOS SISTEMA DE DRENAGEM

MOD. Máxi
Máquina de soldadura topo-a-topo



HDPE

COD.	D	kg		QMM	€/un
PC10000470005	90÷315	217,900	1	1	19 457.33 €

Máquina de eletrossoldadura universal Valsir



HDPE

COD.	D	kg		QMM	€/un
PC10000464333	40÷315	5,357	1	1	2 391.79 €

Máquina de eletrossoldadura Valsir 40-160 V2



HDPE

COD.	D	kg		QMM	€/un
PC10000464010	40÷160	3,365	1	1	1 109.46 €

Raspa tubo



HDPE

COD.		kg		QMM	€/un
PC10000465333		0,092	1	1	28.10 €

Corta tubo



PP3 - TRIPLUS - BLACKFIRE - SILERE - HDPE

COD.	D	Mod.	kg		QMM	€/un
PC10000458011	6÷76	T1	0,550	1	1	214.88 €
PC10000458003	50÷140	T2	1,309	1	1	309.47 €
PC10000458005	100÷168	T3	1,384	1	1	368.93 €

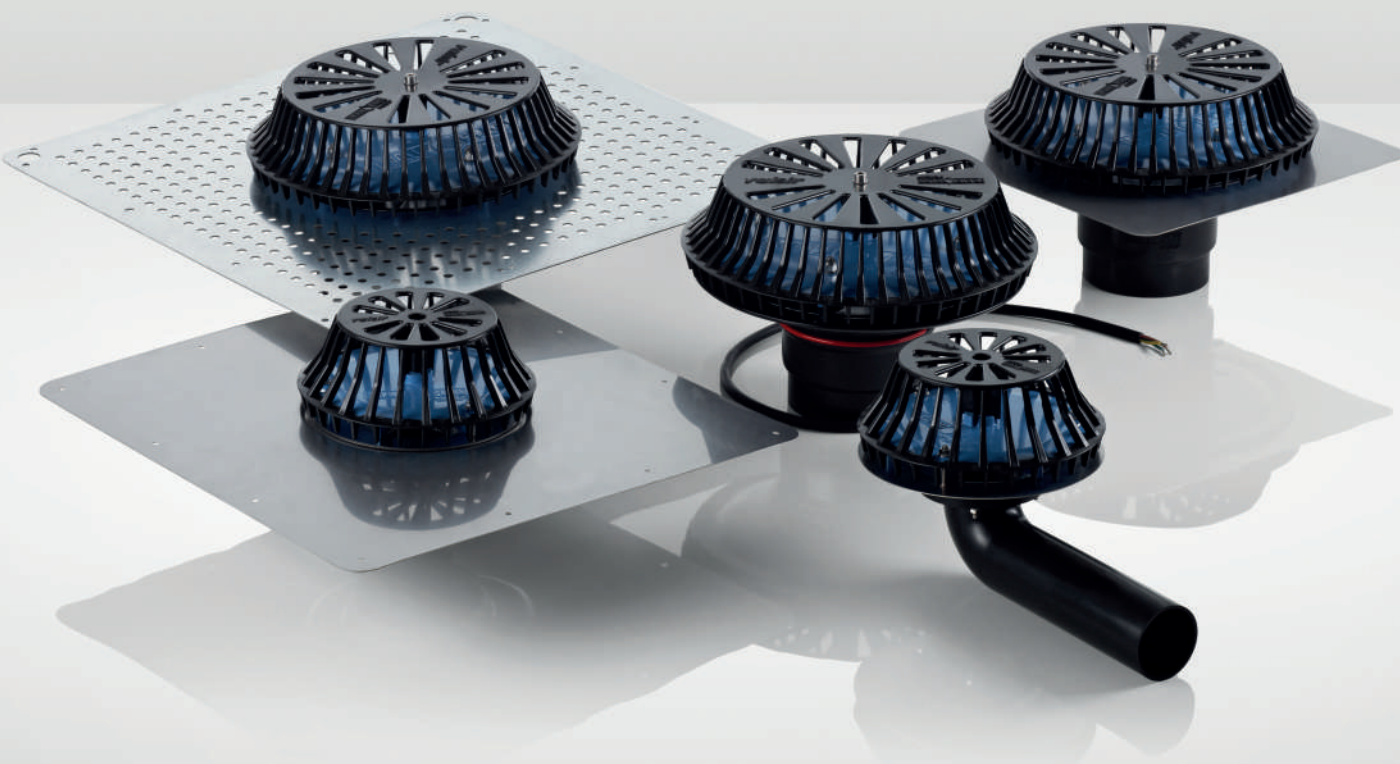

RAINPLUS®: sistema sifónico de drenagem pluvial

RAINPLUS®, A ÚNICA SOLUÇÃO EM CASO DE CHUVA



Rainplus® é o sistema de drenagem sifónico de águas pluviais projetado para atingir as máximas prestações de defluxo com a mais baixa altura de lâmina de água acumulada sobre o teto.





O sistema utiliza a altura do edifício como força motriz, permitindo atingir elevadas velocidades de escoamento maximizando assim a eficiência de drenagem.





Rainplus® permite direccionar o caudal de drenagem para qualquer parte do edifício, permitindo deste modo uma maior facilidade na estratégia de recuperação e reutilização das águas pluviais. A recolha e a poupança da água são parâmetros que são tidos em conta para a obtenção do “Green Building”.

O sistema de drenagem sifónico Rainplus® é constituído por ralos sifónicos especiais que são projetados e testados de acordo com a American Standard ASME A112.6.9 e European Standard EN 1253. Estes ralos sifónicos são ligados a uma rede de tubos e acessórios Valsir em HDPE.

Os ralos são dotados de componentes particulares que permitem a instalação em qualquer tipo de cobertura e tela impermeabilizante.



-  Apenas dois ralos para uma ampla gama de caudais de drenagem.
-  Maior velocidade de instalação e reduzidos trabalhos de escavação graças ao reduzido número de tubagens enterradas.
-  Económico quando comparado com um sistema tradicional. Requer um número menor de ralos de drenagem, uma redução significativa dos diâmetros da tubagem, um menor número de acessórios e de tubos de queda.
-  Altura de água acumulada na cobertura para funcionamento sifónico extremamente reduzida.

-  Poupança de espaço graças a coletores instalado sem qualquer necessidade de inclinação e o tubo de queda posicionado no perímetro do edifício.
-  Máxima flexibilidade no projeto na definição dos circuitos de drenagem.
-  Adaptado a todas as tipologias de coberturas e telas impermeabilizantes.
-  Elevada fiabilidade de ligação com o sistema HDPE Valsir.



GAMA RAINPLUS

**Ralo Sifónico
Rainplus® 110,
1-65 l/s**

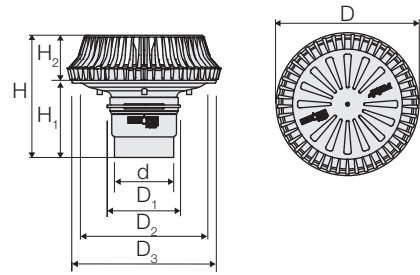

COD.	d	D	H	D ₁	D ₂	D ₃	H ₁	H ₂	kg		QMM	€/un
PB21000420001	110	286	193	136	238	268	122	71	2,736	1	1	101.26 €

**Placa metálica
para coberturas
impermeabilizadas
Rainplus® 110**

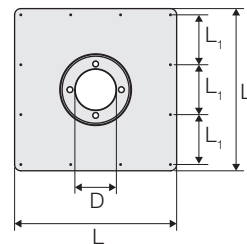

COD.	Mat.	L	L ₁	D	kg		QMM	€/un
PB21000420150	Aço zincado, espessura 1 mm	520	160	131	2,228	1	1	36.42 €

**Placa metálica para
instalação em caleira
Rainplus® 110**

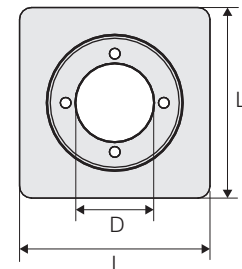

COD.	Mat.	L	D	kg		QMM	€/un
PB21000420151	Aço zincado, espessura 1 mm	320	131	0,821	1	1	31.64 €

**Ralo sifónico
Rainplus® 56 para
caleira, até 14l/s,
ligação vertical**

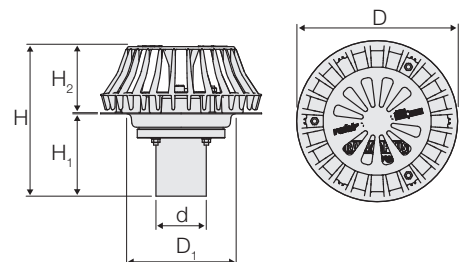

COD.	d	D	H	D ₁	H ₁	H ₂	kg		QMM	€/un
PB21000420005	56	180	166	122	92	74	0,731	1	1	111.59 €

Ralo sífónico Rainplus® 56 para caleira, até 14l/s, ligação horizontal

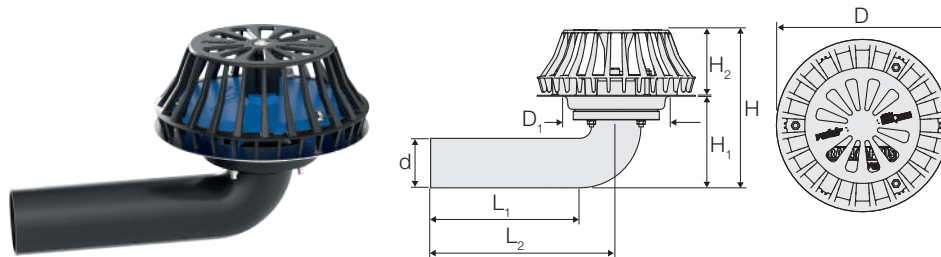

COD.	d	D	D ₁	H	H ₁	H ₂	L ₁	L ₂	kg		QMM	€/un
PB21000420007	56	180	122	178	104	74	169	210	0,820	1	1	111.59 €

Ralo sífónico Rainplus® 56 para coberturas impermeabilizadas, até 14l/s, ligação vertical

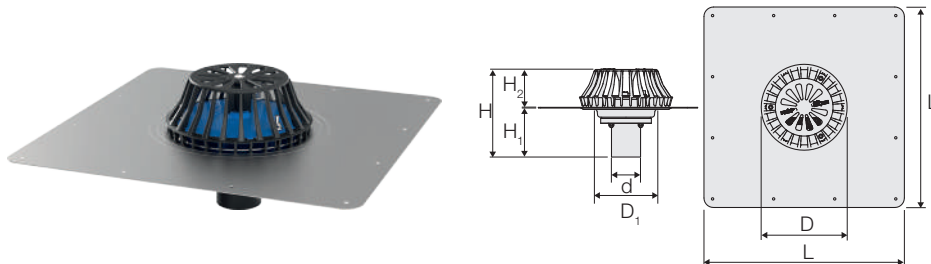

COD.	d	D	D ₁	H	H ₁	H ₂	L	kg		QMM	€/un
PB21000420015	56	180	122	169	95	74	420	2,223	1	1	124.01 €

Ralo sífónico Rainplus® 56 para coberturas impermeabilizadas, até 14l/s, ligação horizontal

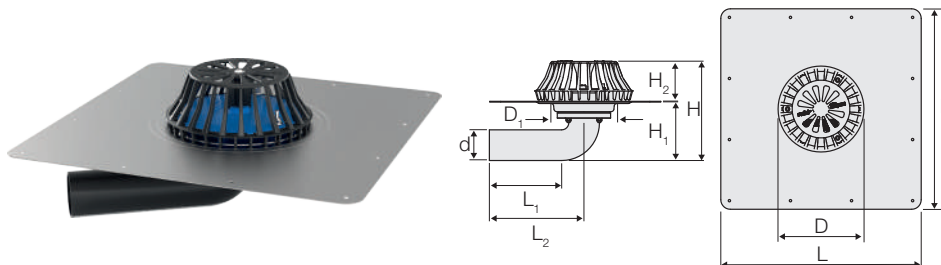

COD.	d	D	D ₁	H	H ₁	H ₂	L	L ₁	L ₂	kg		QMM	€/un
PB21000420017	56	180	122	181	107	74	420	169	210	2,302	1	1	124.01 €

Rainplus® ThermoKit

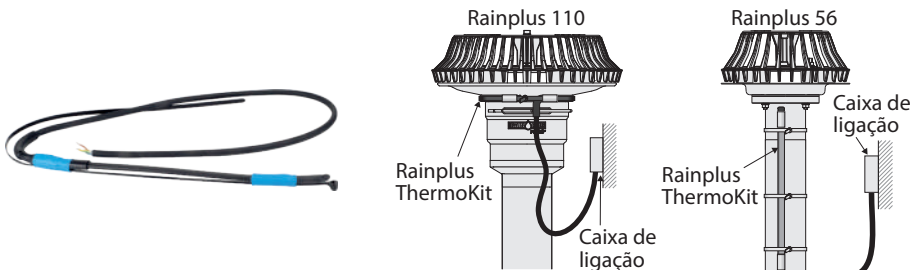

COD.	Potência	Tensão nominal	Grau de proteção	kg		QMM	€/un
PB21000420198	25 W/m	220 V	IP65	0,165	1	1	92.22 €

GAMA RAINPLUS

**Kit Overflow
Para ralo sífónico
Rainplus® 110,
até 65 l/s**

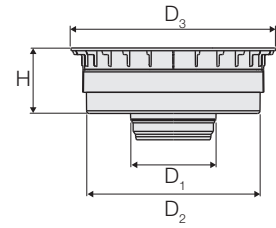

COD.	D ₁	D ₂	D ₃	H	kg		QMM	€/un
PB21000420059	97,8	225,5	265,5	35÷85	0,778	1	1	71.07 €

**Kit Overflow
para ralo sífónico
Rainplus® 56,
até 14 l/s**

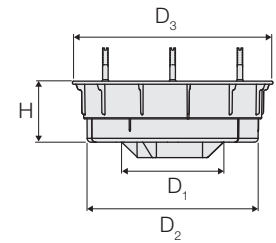

COD.	D ₁	D ₂	D ₃	H	kg		QMM	€/un
PB21000420057	106	155	181	35÷55	0,279	1	1	58.61 €

**Colar galvanizado
M10**

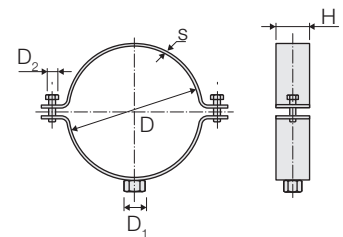

COD.	D	D ₁	D ₂	H	s	kg		QMM	€/un
PB21000396021	40	M10	M6	30	2,5	0,158	50	1	4.18 €
PB21000396023	50	M10	M6	30	2,5	0,177	50	1	4.57 €
PB21000396024	56	M10	M6	30	2,5	0,184	50	1	5.04 €
PB21000396025	63	M10	M6	30	2,5	0,199	50	1	5.04 €
PB21000396027	75	M10	M6	30	2,5	0,220	25	1	5.04 €
PB21000396029	90	M10	M6	30	2,5	0,250	25	1	5.04 €
PB21000396031	110	M10	M6	30	2,5	0,286	25	1	5.04 €
PB21000396033	125	M10	M6	30	2,5	0,309	25	1	5.70 €
PB21000396035	160	M10	M6	30	2,5	0,376	25	1	6.42 €

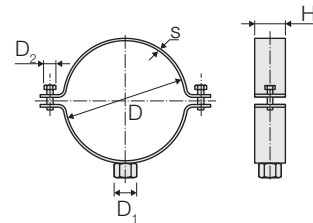
**Colar Galvanizado
G1"**

COD.	D	D ₁	D ₂	H	s	kg		QMM	€/un
PB21000396050	200	G1"	M8	40	4	0,651	4	1	20.48 €
PB21000396052	250	G1"	M8	40	4	1,270	4	1	22.55 €
PB21000396054	315	G1"	M8	40	4	1,564	4	1	23.68 €

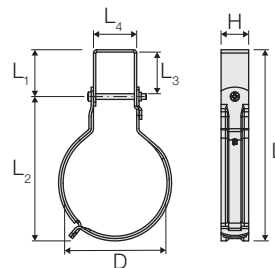
**Colar zincado
Rainplus-S para perfil
de suporte**

COD.	D	L	L ₁	L ₂	L ₃	L ₄	H	Kg		QMM	€/un
PB21000420202	50	137	50	87	44	47	30	0,219	1	1	6.20 €
PB21000420203	56	148	50	98	44	47	30	0,250	1	1	6.04 €
PB21000420204	63	155	50	105	44	47	30	0,258	1	1	6.11 €
PB21000420205	75	167	50	118	44	47	30	0,290	1	1	6.27 €
PB21000420206	90	182	50	133	44	47	30	0,306	1	1	6.53 €
PB21000420207	110	202	50	153	44	47	30	0,338	1	1	6.95 €
PB21000420208	125	217	50	168	44	47	30	0,367	1	1	7.33 €
PB21000420209	160	252	50	203	44	47	30	0,426	1	1	8.42 €
PB21000420210	200	292	50	243	44	47	30	0,496	1	1	10.57 €
PB21000420211	250	340	52	288	46	47	30	0,690	1	1	24.16 €
PB21000420212	315	405	52	353	46	47	30	0,821	1	1	29.88 €

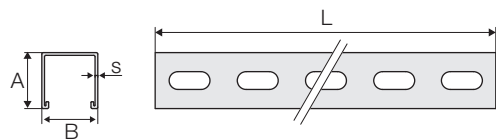
Perfil de suporte

COD.	L	A	B	s	kg		QMM	€/un
PB21000001238	6000	41	41	1,5	2,005	5	1	67.71 €

Perfil de suporte para os colares de fixação Rainplus®.

GAMA RAINPLUS

Placa de união perfis
barra de suporte

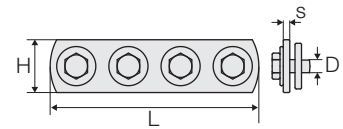

COD.	L	H	s	D	kg		QMM	€/un
PB21000001243	156	40	5	M10	0,557	5	1	8.78 €

Flange de fixação

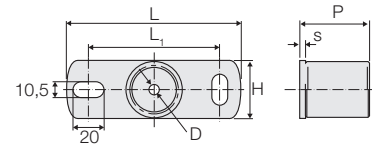

COD.	D	L	H	P	s	L ₁	kg		QMM	€/un
PB21000398005	G1"	120	40	50	4	90	0,236	25	25	7.99 €
PB21000398007	M10	80	30	13	2	52	0,060	25	25	3.48 €

Placa em U



COD.	kg		QMM	€/un
PB21000420192	0,041	100	1	1.40 €

Varão roscado M10

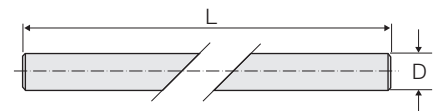

COD.	D	L	kg		QMM	€/un
PB21000408001	M10	1000	0,418	1	1	2.55 €

Porca M10



COD.	kg		QMM	€/un
PB21000420193	0,010	100	1	0.16 €

Anilha 10,5x40x2 mm

COD.	kg		QMM	€/un
PB21000420194	0,025	100	1	0.36 €

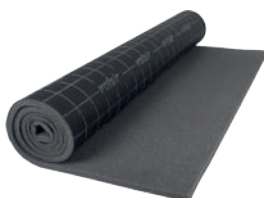
Isolamento termoacústico para tubos de drenagem

COD.	Dimensões LxH	s	kg	 (m²)	QMM	€/un
PC10000399252	2000x1000	14	4,814	2	1	183.66 €

É composto por uma resina de poliuretano expandido autoextinguente de células abertas de espessura de 12 mm e densidade de 30 kg/m³, ligada a uma cama de borracha antichama de 4 kg/m³ com espessura de 2 mm. Não contém chumbo, betume ou outras substâncias nocivas.



Gama de sifões em PP e PEAD

SIFÕES E RALOS: UM MUNDO DE SOLUÇÕES DE PRESTAÇÕES ELEVADAS



SIFÕES

Como complemento à gama de drenagem, a Valsir apresenta uma GAMA de soluções inovativas e patenteadas adotadas a cada exigência e tipologia de instalação.

eficácia na drenagem e, graças à dupla vedação hidráulica, tem uma capacidade de garantir a vedação aos odores em valores superiores ao previsto nas normas.

O sifão rebaixado T-58, por exemplo, com a sua altura de 58 mm, representa a solução ideal para instalações de espessuras reduzidas ou com limitações de altura, garantindo a máxima





GAMA completa e de integração com as linhas de drenagem PEAD e PP, capaz de realizar qualquer tipologia de instalação.



Sistemas rebaixados para instalações de espessura reduzida.



Sistemas compostos de sifões e de tela em PVC para impermeabilização.



Design funcionais e inovativos.



Completamente inspecionáveis.



Compatível com todas as tipologias de tubagens presentes no mercado.



Produtos com materiais tecnologicamente avançados.



Sistemas reguláveis para instalações exigentes.





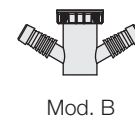
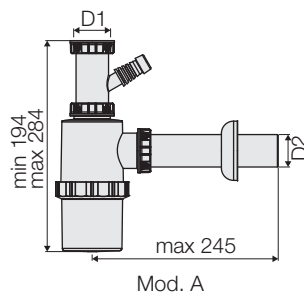

O produto, a sua reciclabilidade e os processos produtivos são baseados nos princípios do Green Building.

COZINHA - SIFÃO PARA LAVA-LOUÇA 1 PIA





Sifão garrafa para lava-louça 1 pia

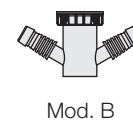
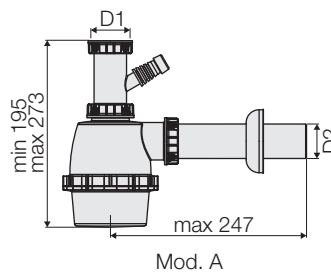

COD.	Mod.	Tipo	D1	D2		QMM	€/un
 PB50000700601	A	1 pia	1"½	40	5	5	5.58 €
 PB50000700603	A	1 pia	1"¼	40	5	5	5.95 €
 PB50000700602	B	1 pia	1"½	40	5	5	6.35 €





Sifão rebaixado para lava-louça 1 pia

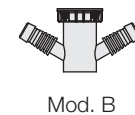
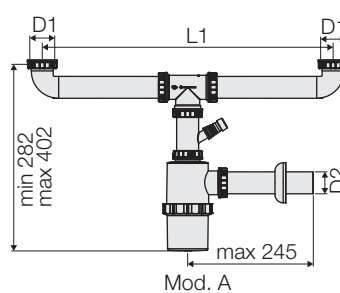

COD.	Mod.	Tipo	D1	D2		QMM	€/un
 PB50000700625	A	1 pia	1"¼	32	5	5	5.58 €
 PB50000700623	A	1 pia	1"¼	40	5	5	5.95 €
 PB50000700621	A	1 pia	1"½	40	5	5	5.58 €
 PB50000700622	B	1 pia	1"½	40	5	5	6.35 €

Sifão garrafa para lava-louça 2 pias



COD.	Mod.	Tipo	D1	D2	L1		QMM	€/un
 PB50000700605	A		1"½	40	máx 553	5	5	9.79 €
 PB50000700606	B	2 pias	1"½	40	máx 553	5	5	10.81 €
 PB50000700607	A	2 pias	1"¼	40	máx 303	5	5	10.10 €

Sifão rebaixado para lava-louça 2 pias

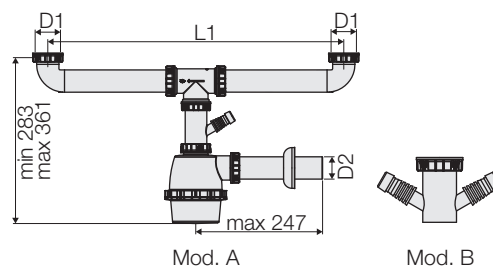

COD.	Mod.	Tipo	D1	D2	L1		QMM	€/un
PB50000700631	A	2 pias	1"¼	32	máx 303	5	5	9.79 €
PB50000700629	A	2 pias	1"¼	40	máx 303	5	5	10.10 €
PB50000700627	A	2 pias	1"½	40	máx 553	5	5	9.79 €
PB50000700628	B	2 pias	1"½	40	máx 553	5	5	10.81 €

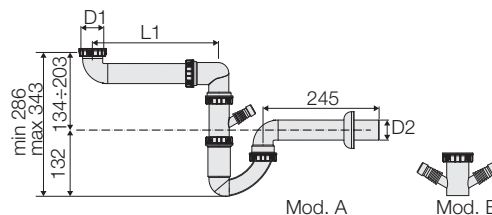

Sifão autolimpante poupa espaço para lava-louça 1 pia

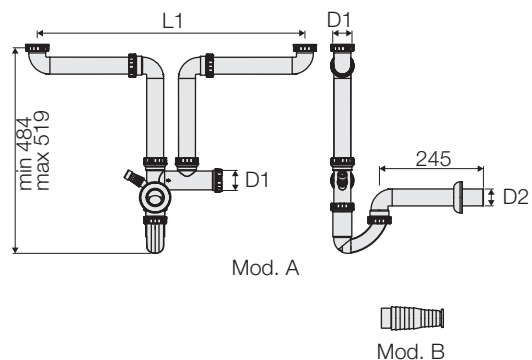

COD.	Mod.	Tipo	D1	D2	L1		QMM	€/un
PB50000700641	A	xx	1"½	40	máx 289	5	5	11.25 €
PB50000700642	B	xx	1"½	40	máx 289	5	5	12.15 €

Sifão autolimpante poupa espaço para lava-louça 2 pia





COD.	Mod.	Tipo	D1	D2	L1		QMM	€/un
 PB50000700643	A	2 pias	1"½	40	máx 645	5	5	16.04 €
 PB50000700644	B	2 pias	1"½	40	máx 645	5	5	17.11 €

BANHO - SIFÕES PARA LAVATÓRIOS E BIDÉ

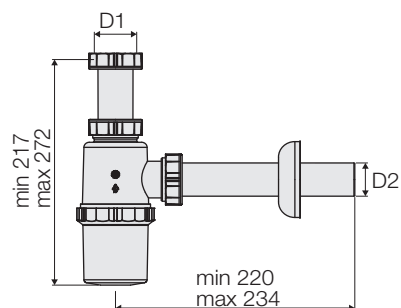
Sifão garrafa



COD.	Mod.	D1	D2		QMM	€/un
 PB50000700342	lavatório simples	1"¼	32	5	5	5.17 €
 PB50000700341	lavatório simples	1"¼	40	5	5	5.41 €

Sifão para lavatório em PP branco



Mod. A1

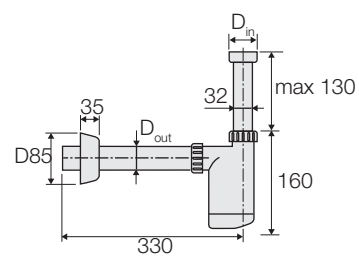

Mod. A2

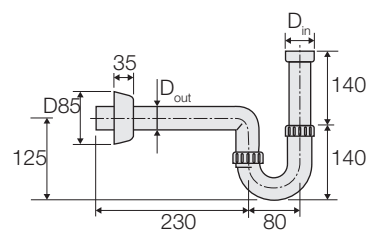

COD.	Mod.	D _{out}	D _{in}				QMM	€/un
PB50000700223	A1	40	1 1/4	5	40	280	5	5.08 €
PB50000700231	A1	40	1 1/4	5	40	280	5	14.32 €
PB50000700214	A2	32	1 1/4	5	40	280	5	7.84 €

Sifão em "U" autolimpante para lavatório

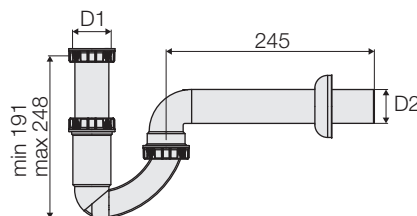





COD.	Tipo	D1	D2		QMM	€/un
PB50000700204	lavatório simples	1 1/4	40	5	5	7.60 €

BANHO - BASE DE DUCHE

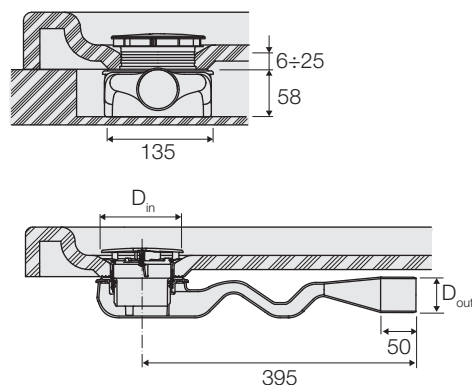
T-58

Sifão rebaixado em PP para pratos de duche D 90





COD.	D _{out}	D _{in}	Furo prato de duche	Ligação				QMM	€/un
PB50000700291	50	115	90	horizontal	1	12	96	1	27.30 €

RALOS DE PAVIMENTO E TERRAÇOS

T-58

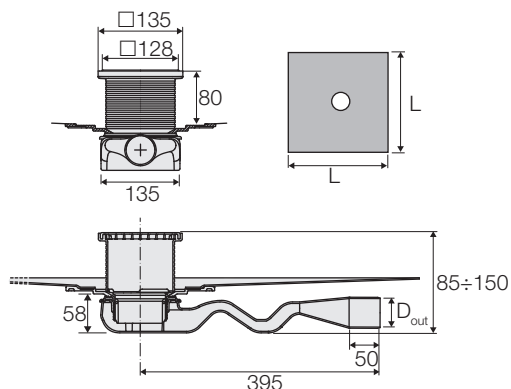
Sifão rebaixado em PP com tela 1800x1800 mm



COD.	D _{out}	Tela LxL	Ligação	Tela		QMM	€/un
PB50000700385	50	1800x1800	horizontal	furo	1	1	166.86 €

Ralo de pavimento completo em PP, sifonado e inspecionável, ligação vertical ou horizontal orientável

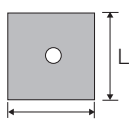

Mod. A

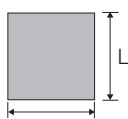

Mod. B

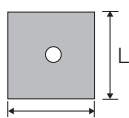
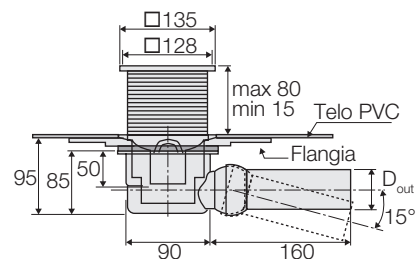

Mod. A

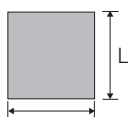

Mod. B

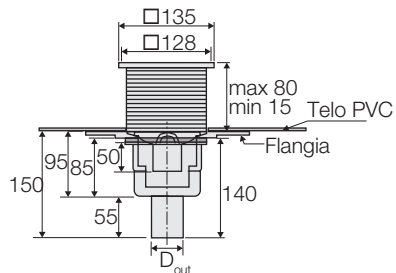





SIFÕES

COD.	Mod.	D _{out}	Tela LxL	Ligação	Tela				QMM	€/un
PB50000700360	A	50	1200x1200	horizontal orientável	furo	1	8	40	1	117.31 €
PB50000700361	A	50	1600x1600	horizontal orientável	furo	1	8	40	1	162.65 €
PB50000700362	A	50	1800x1800	horizontal orientável	furo	1	8	40	1	206.74 €
PB50000700370	A	50	1200x1200	vertical	furo	1	8	40	1	117.31 €
PB50000700371	A	50	1600x1600	vertical	furo	1	8	40	1	162.65 €
PB50000700365	B	50	1800x1800	horizontal orientável	Sem furo	1	8	40	1	198.81 €
PB50000700375	B	50	1800x1800	vertical	Sem furo	1	8	40	1	198.81 €
PB50000700368	-	50	-	horizontal orientável	-	1	8	40	1	66.78 €
PB50000700377	-	50	-	vertical	-	1	8	40	1	66.78 €

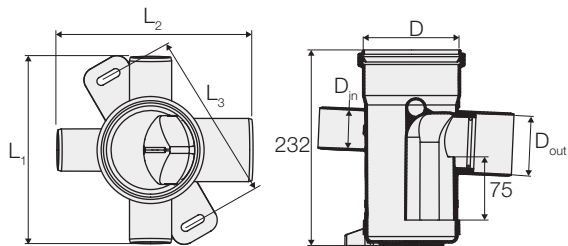
T-TRAP

Ralo em Triplus, sifonado e inspecionável, ligações verticais e horizontais



COD.	D	D _{in}	D _{out}	L ₁	L ₂	L ₃				QMM	€/un
PB50000701741	110	3x50	1x75	220	230	200	5	20	60	5	33.42 €

Ralo sifonado em Triplus constituído por uma entrada superior de diâmetro 110 mm com boca e o-ring, 3 entradas laterais diâmetro 50 mm, 1 saída lateral diâmetro 75 mm. O ralo é dotado de um fecho hídrico de 75 mm. é fornecido com suporte inferior completo para montagem no teto.

Ralo em Triplus H 170 , sifonado e inspecionável, ligações verticais e horizontais

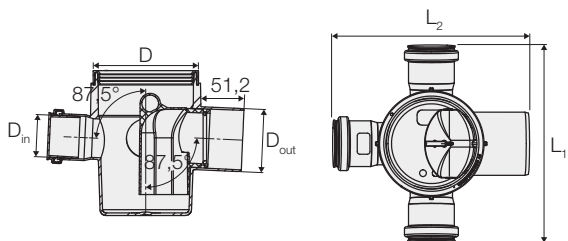

COD.	D	D _{in}	D _{out}	L ₁	L ₂				QMM	€/un
 PB50000701743	110	3x50	1x75	232	232	5	20	60	5	26.61 €

Ralo pavimento em PP, sifonado e inspecionável, com ligações de rosca

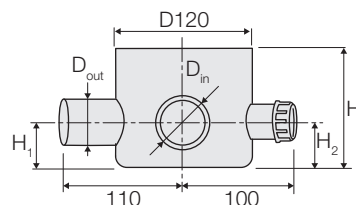

COD.	D _{out}	D _{in}	H	H ₁	H ₂				QMM	€/un
 PB50000701011	50	4x40	100	40	40	10	40	120	10	9.14 €

Ralo pavimento em PP, sifonado e inspecionável, com ligações de rosca

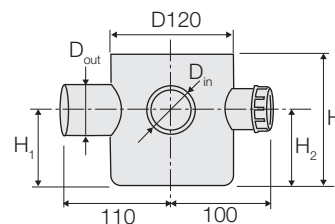

COD.	D _{out}	D _{in}	H	H ₁	H ₂				QMM	€/un
PB50000701050	50	4x40	135	75	75	10	40	280	10	10.31 €

Ralo pavimento em PP, sifonado e inspecionável, com ligações de rosca

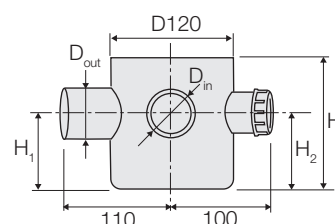

COD.	D _{out}	D _{in}	H	H ₁	H ₂				QMM	€/un
PB50000701075	75	4x40	135	75	75	10	70	280	10	12.09 €

Ralo de pavimento completo em PP, inspecionável

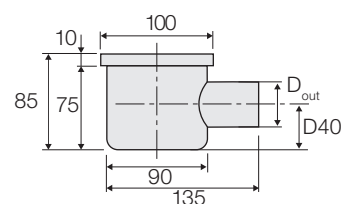

COD.	D _{out}				QMM	€/un
PB50000700380	40	15	120	480	15	8.82 €

Ralo de pavimento completo em PP, sifonado e inspecionável

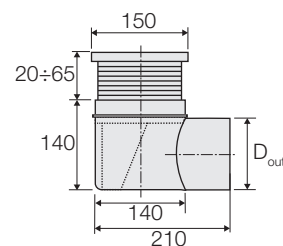

COD.	D _{out}				QMM	€/un
PB50000700301	75	2	16	80	2	97.53 €
PB50000700303	110	2	16	80	2	97.53 €

Ralo produzido em polipropileno (PP) com uma saída horizontal de 75 mm ou 100 mm segundo o modelo. O ralo é fornecido com tela e grelha em aço inox 150x150 mm, prolongamento regulável 20 a 65 mm e filtro antifolha.

Ralo pavimento completo em PEAD inspecionável

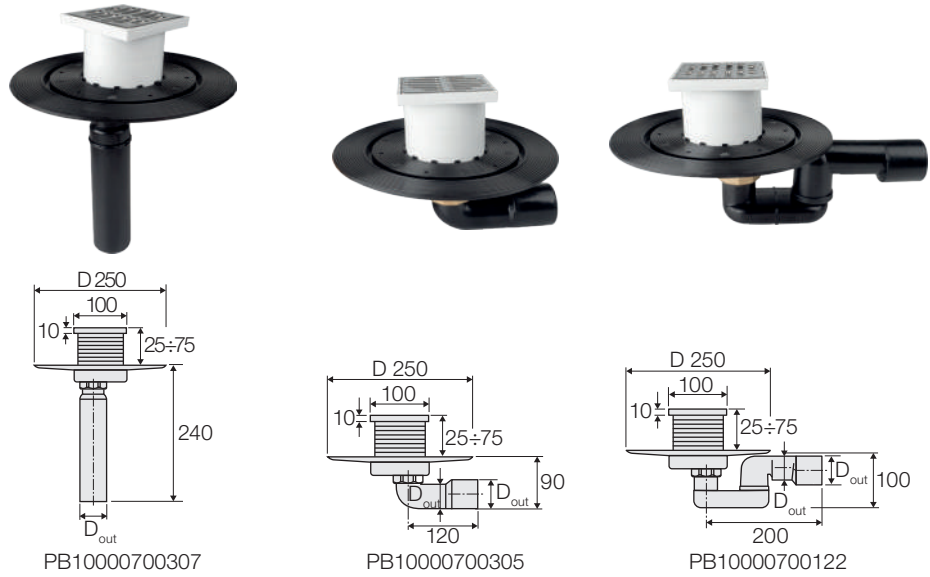

COD.	D _{out}				QMM	€/un
PB50000700307	50	1	16	80	1	37.95 €
PB50000700305	50/40	1	16	80	1	23.13 €
PB50000700122	50/40	1	16	80	1	26.27 €

Ralo realizado em polietileno (PEAD) com 1 saída diâmetro 50 mm o 40/50 mm dependendo do modelo. a ligação de duplo diâmetro é extremamente útil nos caso em que não se conhece o diâmetro do tubo de ligação.

Sifão de encastrar para máquina de lavar

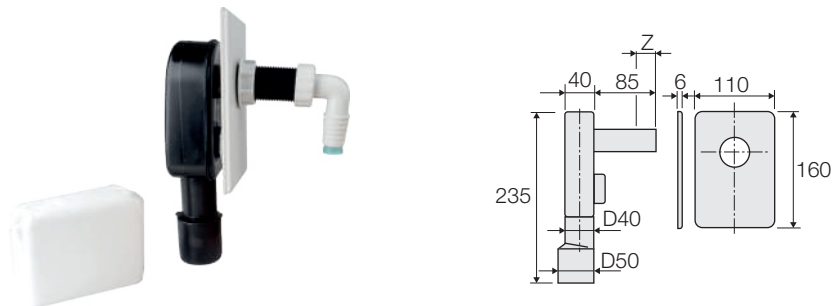

COD.	D _{out}	Z*	Placa de acabamento				QMM	€/un
PB50000700185	40/50	40	polipropileno (PP) branco	20	80	240	20	12.46 €
PB50000700035	40/50	40	aço inox	20	80	240	20	12.38 €

*Corte máximo permitido.

Sifão para máquina de lavar completo de placa de acabamento, o-ring, fixação e tampão de inspeção.

Válvula admissão ar

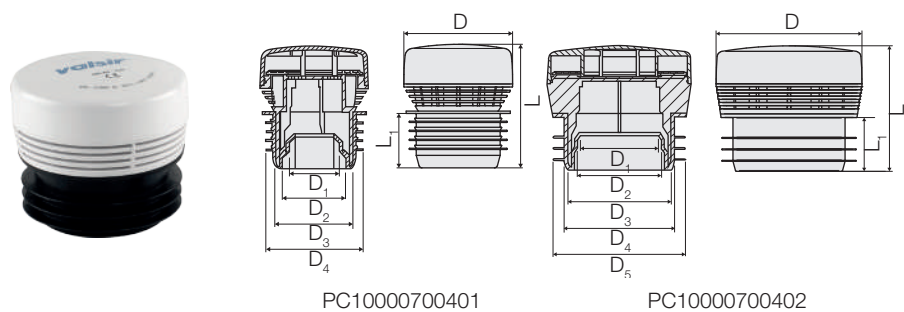

COD.	D	D ₁	D ₂	D ₃	D ₄	D ₅	L	L ₁		QMM	€/un
PC10000700401	70	32	40	50	63	-	79,5	35	12	1	19.11 €
PC10000700402	125	70	75	90	100	110	108	46	6	1	37.19 €



Pexal®: sistema multicamada para abastecimento

PEXAL®, O SISTEMA DE EXCELÊNCIA

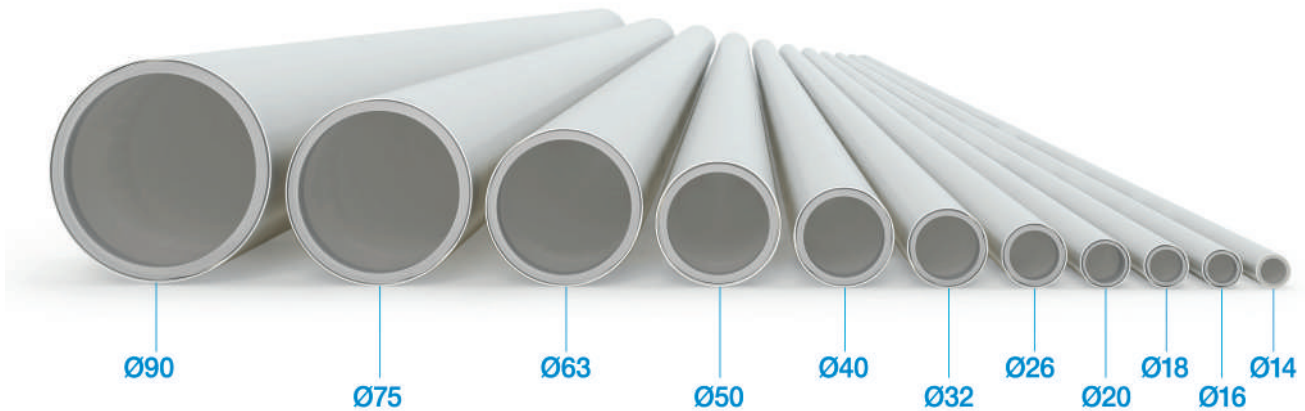

Pexal® é um sistema composto por tubagem multicamada e acessórios de diversa tipologia capazes de responder às mais diversas exigências de instalação e diferentes aplicações: da distribuição da água quente e fria, às distribuições centralizadas, aos sistemas de aquecimento sejam de radiadores, convetores ou pavimento radiante, terminando em sistemas de distribuição de ar comprimido em ambientes industriais.

A tubagem multicamada Pexal® une as vantagens dos materiais plásticos e em particular do polietileno reticulado, entre as quais resistência à abrasão, à corrosão e aos agentes químicos com as do alumínio, como a resistência a elevadas temperaturas e pressão, a estabilidade dimensional, a impermeabilidade ao oxigénio e à luz e a baixa dilatação térmica.



SISTEMA
DISTRIBUIÇÃO

GAMA PEXAL



Une as vantagens típicas do tubo metálico às do tubo plástico.



Temperatura máxima de trabalho de 95°C a 10 bar.



Total impermeabilização ao oxigénio graças à camada interna em alumínio.



Reticulação quer na camada externa quer na camada interna.



Um único tubo para variadas aplicações: sistemas de distribuição sanitária, sistemas de aquecimento e arrefecimento a alta e baixa temperatura e distribuição de ar comprimido.



Extrema facilidade e velocidade de instalação: uma vez curvado o tubo mantém a curvatura. É possível curvá-lo várias vezes.



Certificado para o transporte de água potável.



Disponível em varas ou em rolo e com isolamentos de 6 e 10 mm.



Elevado grau de higiene.

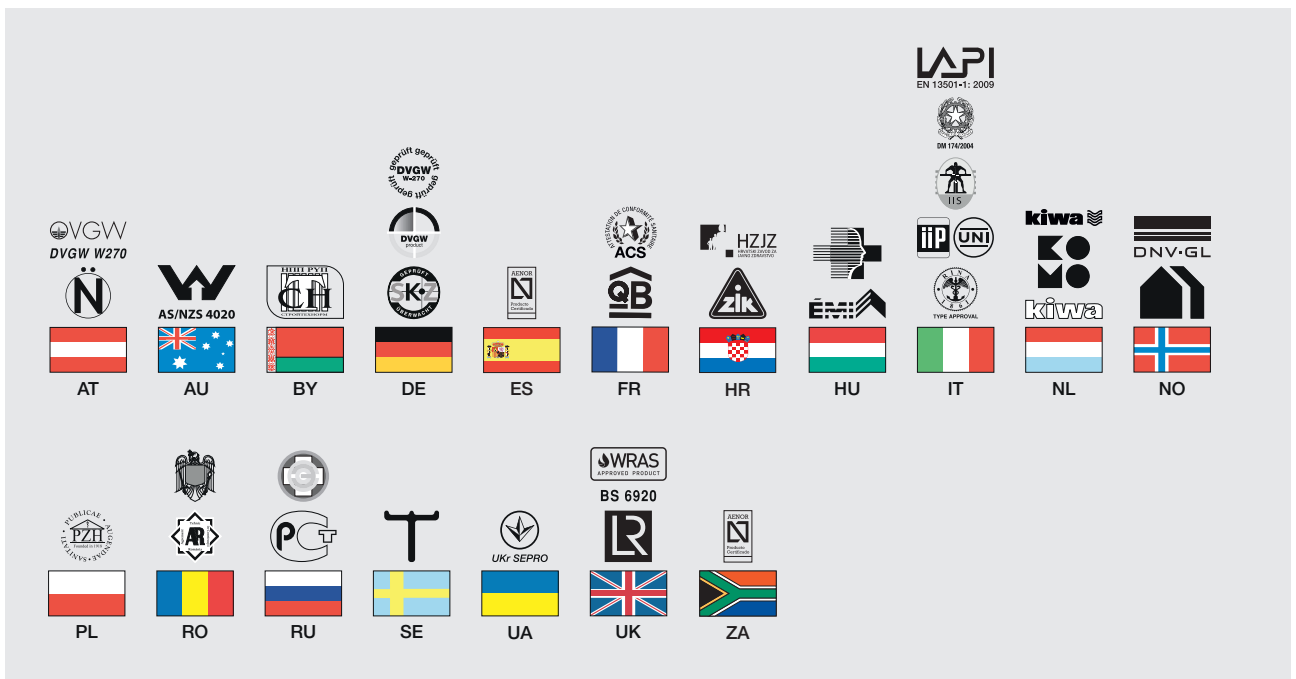

**Tubo multicamada
Pexal® em rolo**

COD.	Dxs	□ (m)	📦 (m)	QMM	€/un
PA10000100107	16x2	100	5600	1	153.39 €
PA10000100115	20x2	100	3200	1	202.85 €
PA10000100117	26x3	50	1200	1	226.33 €
PA10001100119	32x3	50	800	1	339.25 €

**Tubo multicamada
Pexal® isolado
com isolamento
autoextinguente em
rolo**

COD.	Dxs	Espessura isolamento	Cor	□ (m)	📦 (m)	QMM	€/un
PA10001100293	16x2	6	vermelho	50	2000	1	99.18 €
PA10001100291	16x2	6	azul	50	2000	1	99.18 €
PA10001100297	20x2	6	vermelho	50	1400	1	126.91 €
PA10001100295	20x2	6	azul	50	1400	1	126.91 €
PA10000100286	20x2	10	vermelho	50	1000	1	155.14 €
PA10000100465	20x2	10	azul	50	1000	1	155.14 €
PA10000100456	26x3	6	azul	50	900	1	263.30 €
PA10000100457	26x3	6	vermelho	50	900	1	263.30 €
PA10000100287	26x3	10	vermelho	50	900	1	311.02 €
PA10000100469	26x3	10	azul	50	900	1	311.02 €
PA10001100219	32x3	10	cinzento	25	550	1	199.98 €
PA10000100288	32x3	10	vermelho	25	550	1	199.98 €

Tubo Pexal® revestido com tubo corrugado



COD.	Dxs	Cor	□ (m)	📦 (m)	QMM	€/un
PA10000125105	16x2	azul	50	2200	1	126.16 €
PA10000125107	16x2	vermelho	50	2200	1	126.16 €
PA10000125109	20x2	azul	50	1500	1	172.12 €
PA10000125111	20x2	vermelho	50	1500	1	172.12 €
PA10000125121	26x3	azul	50	900	1	316.76 €
PA10000125123	26x3	vermelho	50	900	1	316.76 €
PA10000125125	32x3	azul	25	600	1	224.71 €
PA10000125127	32x3	vermelho	25	600	1	224.71 €

Tubo multicamada Pexal® em vara de 5 m



COD.	Dxs	□ (m)	QMM	€/un
PA10000100007	16x2	120	1	8.40 €
PA10000100015	20x2	120	1	11.27 €
PA10000100017	26x3	50	1	24.91 €
PA10000100021	32x3	50	1	37.28 €
PA10000100025	40x3,5	25	1	59.66 €
PA10000100029	50x4	25	1	77.72 €
PA10000100033	63x4,5	15	1	137.65 €
PA10000100034	75x5	15	1	254.31 €
PA10000100081	90x7	5	1	415.24 €



Mixal[®]: o sistema multicamada de elevada flexibilidade

MIXAL[®], O SISTEMA UNIVERSAL PARA A DISTRIBUIÇÃO DE ÁGUA SANITÁRIA

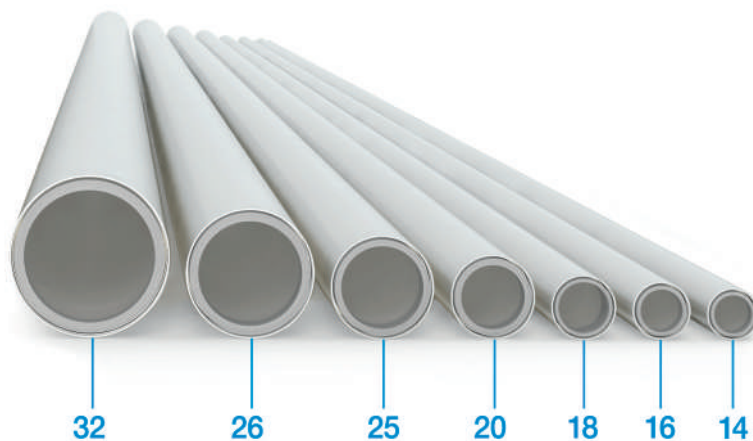

Mixal[®] é um sistema composto por tubagens multicamada e acessórios de diversa tipologia adaptado a qualquer tipo de instalação hidro-termo-sanitária.

Graças à sua extrema flexibilidade, é o produto ideal para a realização de sistemas de aquecimento e arrefecimento por piso radiante. Devido às suas elevadas prestações, é utilizado na distribuição de água potável fria e quente, nos sistemas de aquecimento de radiadores, convetores e em sistemas industriais e também na distribuição de ar comprimido.

A tubagem multicamada Mixal[®] une as vantagens dos materiais plásticos e em particular do polietileno reticulado, entre as quais resistência à abrasão, à corrosão e aos agentes químicos com as do alumínio, como a resistência a elevadas temperaturas e pressão, a estabilidade dimensional, a impermeabilidade ao oxigénio e à luz e a baixa dilatação térmica.





Une as vantagens típicas do tubo metálico às do tubo plástico.



Temperatura máxima de trabalho de 95°C a 10 bar.



Total impermeabilização ao oxigénio graças à camada interna em alumínio.



Reticulação da camada interna.



Um único tubo para variadas aplicações: sistemas de distribuição sanitária, sistemas de aquecimento e arrefecimento a alta e baixa temperatura e distribuição de ar comprimido.



Extrema facilidade e velocidade de instalação: uma vez curvado o tubo mantém a curvatura.



Certificado para o transporte de água potável.



Elevado grau de higiene.

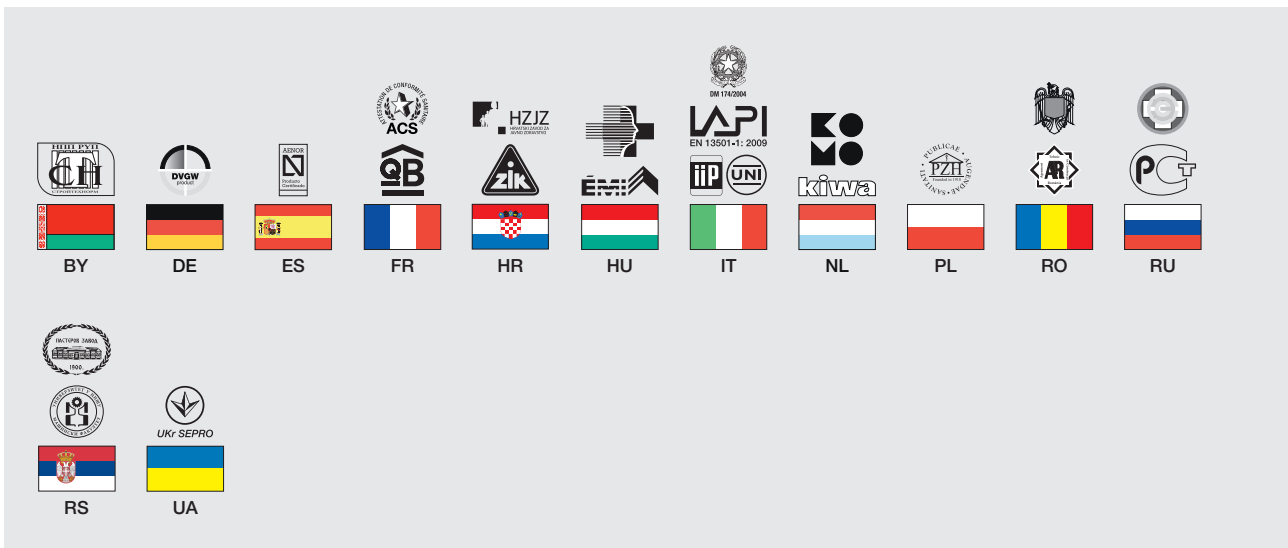

**Tubo multicamada
Mixal® em rolo**

COD.	Dxs	□ (m)	⊞ (m)	QMM	€/un
PA10001100137	16x2	100	5600	1	137.40 €
PA10001100139	20x2	100	3200	1	183.37 €
PA10001100143	26x3	50	1200	1	199.10 €
PA10001100145	32x3	50	800	1	293.78 €

**Tubo multicamada
Mixal® isolado
com isolamento
autoextinguente em
rolo**

COD.	Dxs	Espessura isolamento	Cor	□ (m)	⊞ (m)	QMM	€/un
PA10000100451	16x2	6	vermelho	50	2000	1	92.93 €
PA10000100450	16x2	6	azul	50	1400	1	92.93 €
PA10000100453	20x2	6	vermelho	50	1400	1	115.67 €
PA10000100452	20x2	6	azul	50	1400	1	115.67 €
PA10000100274	20x2	10	vermelho	50	1000	1	138.65 €
PA10000100447	20x2	10	azul	50	1000	1	138.65 €
PA10000100455	26x3	6	vermelho	50	900	1	235.83 €
PA10000100454	26x3	6	azul	50	900	1	235.83 €
PA10000100448	26x3	10	vermelho	50	900	1	283.79 €
PA10000100275	26x3	10	azul	50	900	1	283.79 €



PEXAL[®] Brass: acessórios de prensar em latão

PEXAL® ACESSÓRIOS DE PRENSAR EM LATÃO



Os acessórios Pexal® de prensar realizados com o corpo em liga de latão e anel compressor em aço inox. São adaptáveis a diversas aplicações como distribuição de água potável fria e quente, a sistemas de aquecimento e até sistemas industriais.

Os acessórios são dotados de um anel especial em material polimérico transparente que evita o contacto entre o alumínio do tubo e o latão do acessório evitando corrosão e aumentando a profundidade de inserção do tubo permitindo um melhor controlo.

SISTEMA
DISTRIBUIÇÃO



Matriz de prensagem U, H, C

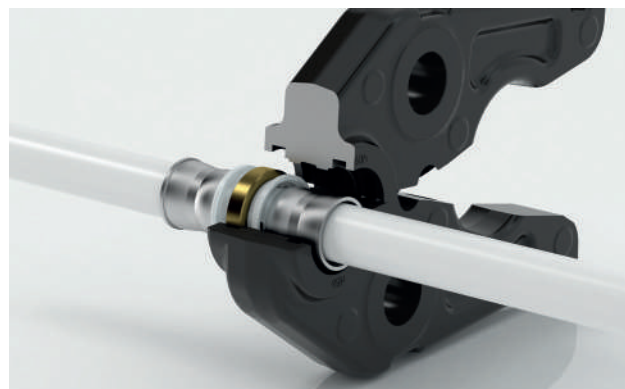

Matriz de prensagem TH



Duplo o-ring que garante a máxima vedação hidráulica.



Realizados em liga especial em latão resistente à corrosão.



Anel de prensagem já montado no acessório em aço inox AISI 304 , com furos de inspeção



Possibilidade de utilizar os produtos seja em instalações sanitárias seja em instalação de aquecimento ou arrefecimento.



Sinalização de perda durante o ensaio da instalação em caso de falta de prensagem ou para prensagens realizadas entre os 0,5 e 2 bar.



Anel especial em PTFE para evitar as corrosões galvânicas entre o tubo e o acessório.



Os diâmetros de 40 a 50 mm estão disponíveis com matrizes de prensagem multiprensar H, TH, U, C, VAL.



Ampla GAMA de diâmetros 40 a 90 mm.

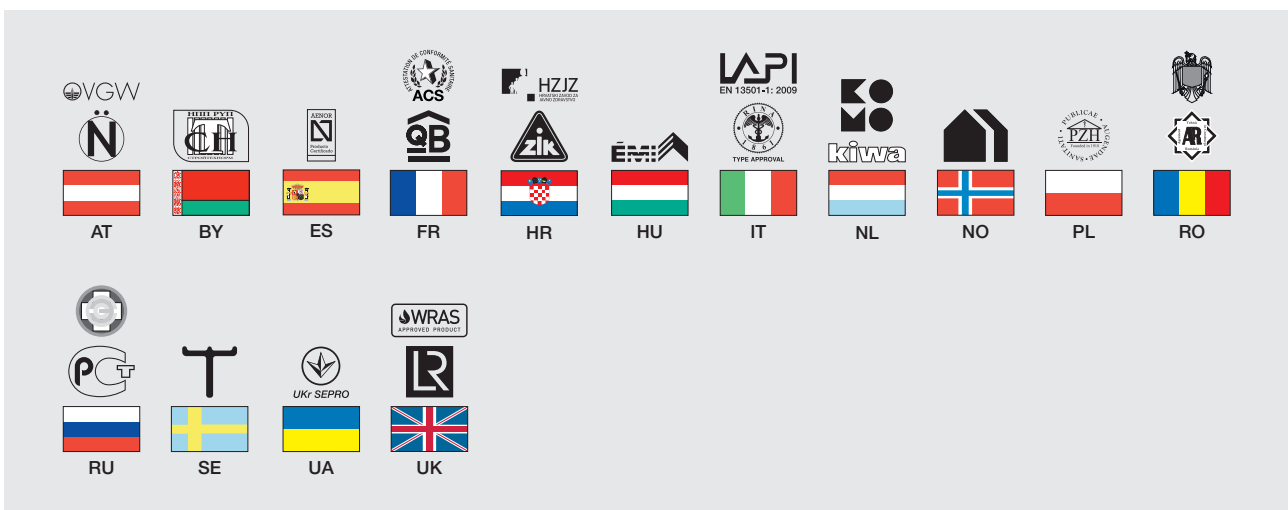

União prensar



COD.	A	ØA	B	ØB	L	Ø	CH			QMM	€/un
PA11000130535	75x5	VAL,U	75x5	VAL,U	166	83	76	1	5	1	136.25 €
PA11000130537	90x7	U	90x7	U	168,5	100	95	1	-	1	266.49 €

União redução

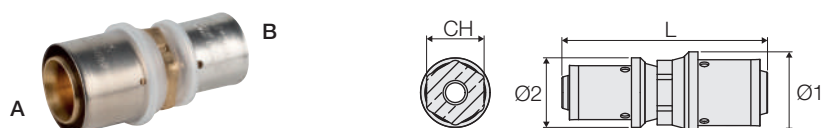

COD.	A	ØA	B	ØB	L	Ø1	Ø2	CH			QMM	€/un
PA11000130583	75x5	VAL,U	50x4	VAL,TH,U	141,5	83	57	76	1	7	1	116.82 €
PA11000130585	75x5	VAL,U	63x4,5	VAL,TH,U	166	83	70	76	1	6	1	131.41 €
PA11000130587	90x7	U	63x4,5	VAL,TH,U	166,5	100	70	95	1	-	1	257.35 €
PA11000130589	90x7	U	75x5	VAL,U	167	100	83	95	1	-	1	262.83 €

União fêmea



COD.	A	ØA	B (pol)	L	Ø	CH			QMM	€/un
PA11000130727	40x3,5	VAL,TH,U	1"1/4	76	55	50	2	30	2	31.95 €
PA11000130729	40x3,5	VAL,TH,U	1"1/2	76	60	55	2	28	2	31.95 €
PA11000130733	50x4	VAL,TH,U	1"1/2	75	60	55	2	26	2	37.33 €
PA11000130739	63x4,5	VAL,TH,U	2"	105,5	78	70	2	12	2	61.15 €
PA11000130743	75x5	VAL,U	2"1/2	112,5	92	85	1	8	1	114.99 €
PA11000130745	90x7	U	3"	118,5	108	98	1	-	1	219.94 €

União macho



COD.	A	Q _A	B (pol)	L	Ø	CH			QMM	€/un
PA11000130627	40x3,5	VAL,TH,U	1"1/4	85	49	45	2	34	2	22.82 €
PA11000130633	50x4	VAL,TH,U	1"1/2	86	57	50	2	26	2	34.50 €
PA11000130635	50x4	VAL,TH,U	2"	93	76	70	2	14	2	47.23 €
PA11000130639	63x4,5	VAL,TH,U	2"	118,5	76	70	2	10	2	62.06 €
PA11000130643	75x5	VAL,U	2"1/2	121,5	92	85	1	7	1	119.55 €
PA11000130645	90x7	U	3"	124,5	108	98	1	-	1	223.59 €

Joelho 45°

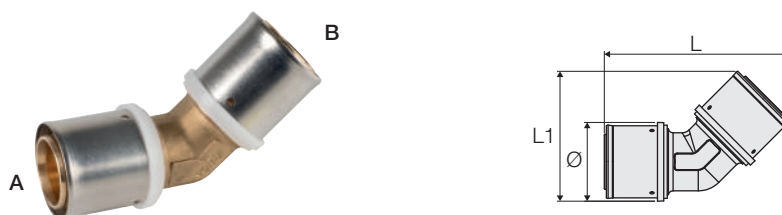

COD.	A	Q _A	B	Q _B	L	L1	Ø			QMM	€/un
PA11000130853	75x5	VAL,U	75x5	VAL,U	194	134,5	83	1	5	1	170.79 €
PA11000130855	90x7	U	90x7	U	213	151	100	1	-	1	333.09 €

Joelho

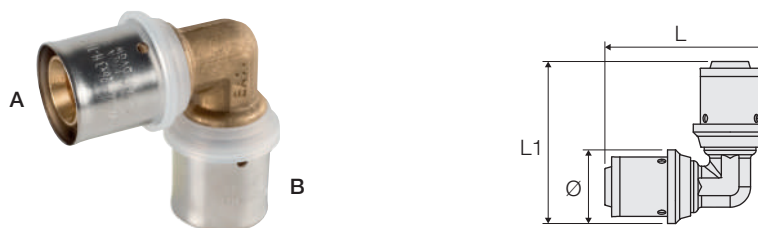

COD.	A	Q _A	B	Q _B	L	L1	Ø			QMM	€/un
PA11000130843	75x5	VAL,U	75x5	VAL,U	169	169	83	1	4	1	180.05 €
PA11000130845	90x7	U	90x7	U	186,5	186,5	100	1	-	1	346.79 €

SISTEMA DISTRIBUIÇÃO

Joelho macho

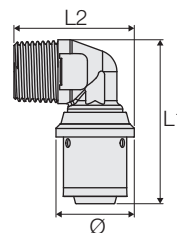
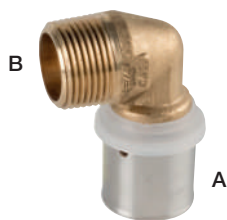

COD.	A	OA	B (pol)	L1	L2	Ø			QMM	€/un
PA11000131027	40x3,5	VAL,U	1"1/4	94	79,5	47	2	24	2	41.07 €
PA11000131033	50x4	VAL,TH,U	1"1/2	105,5	88,5	57	2	18	2	65.72 €
PA11000131035	50x4	VAL,U	2"	120	93,5	57	2	18	2	72.32 €
PA11000131039	63x4,5	VAL,TH,U	2"	140	106	70	2	8	2	118.56 €

Joelho fêmea

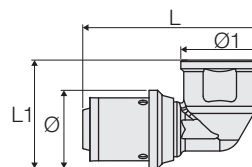
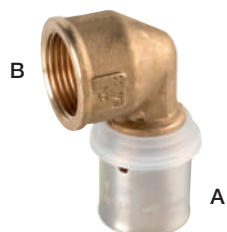

COD.	A	OA	B (pol)	L	L1	Ø	Ø1			QMM	€/un
PA11000130927	40x3,5	VAL,TH,U	1"1/4	99	79,5	47	50	2	22	2	41.82 €
PA11000130933	50x4	VAL,TH,U	1"1/2	109	93	57	56	2	14	2	53.28 €
PA11000130939	63x4,5	VAL,TH,U	2"	145	108	70	68	2	8	2	125.03 €

Tê

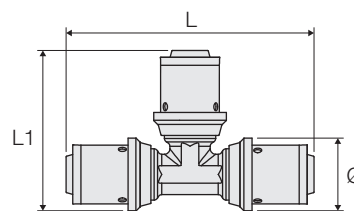
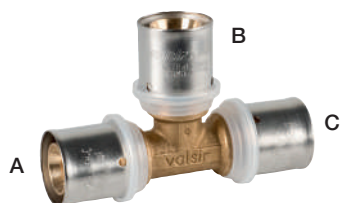

COD.	A	OA	B	OB	C	OC	L	L1	Ø			QMM	€/un
PA11000131143	75x5	VAL,U	75x5	VAL,U	75x5	VAL,U	255	208	83	1	3	1	247.61 €
PA11000131145	90x7	U	90x7	U	90x7	U	273	186,5	100	1	-	1	442.61 €

Tê fêmea

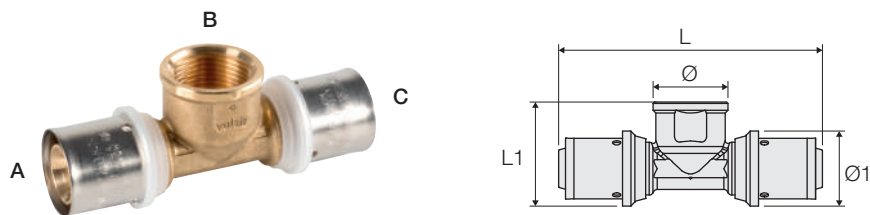

COD.	A	⊗OA	B (pol)	C	⊗OC	L	L1	Ø	Ø1			QMM	€/un
PA11000131327	40x3,5	VAL,TH,U	1"1/4	40x3,5	VAL,TH,U	148	79,5	50	47	2	16	2	53.39 €
PA11000131331	50x4	VAL,TH,U	1"1/4	50x4	VAL,TH,U	162	89	50	57	2	12	2	80.31 €
PA11000131333	50x4	VAL,TH,U	1"1/2	50x4	VAL,TH,U	162	89	56	57	2	10	2	88.50 €
PA11000131339	63x4,5	VAL,TH,U	2"	63x4,5	VAL,TH,U	222	104	68	70	2	6	2	170.06 €
PA11000131343	75x5	VAL,U	1"	75x5	VAL,U	255	115,5	48	83	1	4	1	198.04 €
PA11000131345	75x5	VAL,U	1"1/4	75x5	VAL,U	255	118	48	83	1	4	1	198.95 €
PA11000131347	90x7	U	1"	90x7	U	273	125	54	100	1	-	1	394.24 €
PA11000131349	90x7	U	1"1/4	90x7	U	273	127,5	54	100	1	-	1	401.54 €

Tê redução

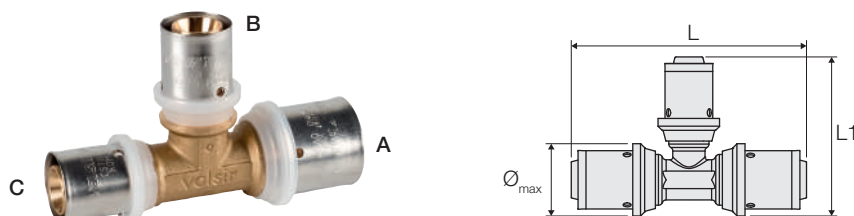

COD.	A	⊗OA	B	⊗OB	C	⊗OC	L	L1	Ø _{máx}			QMM	€/un
PA11000170885	32x3	VAL,H,TH,U	16x2	H,TH,U	16x2	H,TH,U	106,5	71,5	39	5	45	5	20.30 €
PA11000170887	32x3	VAL,H,TH,U	20x2	H,TH,U	20x2	H,TH,U	104	66	39	5	40	5	20.72 €
PA11000170889	32x3	VAL,H,TH,U	32x3	VAL,H,TH,U	16x2	H,TH,U	110	74	39	5	35	5	20.78 €
PA11000170864	40x3,5	VAL,TH,U	32x3	VAL,H,TH,U	32x3	VAL,H,TH,U	125	84,5	47	2	24	2	48.28 €
PA11000131763	75x5	VAL,U	40x3,5	VAL,TH,U	75x5	VAL,U	255	142,5	83	1	4	1	203.06 €
PA11000131765	75x5	VAL,U	50x4	VAL,TH,U	75x5	VAL,U	255	139,5	83	1	4	1	206.70 €
PA11000131767	75x5	VAL,U	63x4,5	VAL,TH,U	63x4,5	VAL,TH,U	250,5	164,5	83	1	4	1	193.61 €
PA11000131769	75x5	VAL,U	63x4,5	VAL,TH,U	75x5	VAL,U	255	164,5	83	1	3	1	220.38 €
PA11000131771	90x7	U	63x4,5	VAL,TH,U	90x7	U	273	175	100	1	-	1	419.80 €
PA11000131773	90x7	U	75x5	VAL,U	90x7	U	273	178,5	100	1	-	1	433.48 €

SISTEMA DISTRIBUIÇÃO

Coletor 2 vias

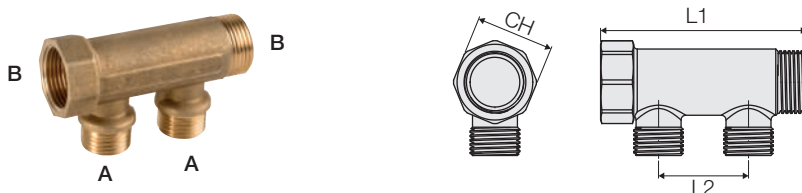

COD.	A (pol)	B (pol)	Saída	L1	L2	CH		QMM	€/un
PA11000132401	1/2"	3/4"	2	87	38	33	5	5	13.59 €
PA11000132413	3/4"	1"	2	87	38	33	5	5	18.56 €

Coletor 3 vias

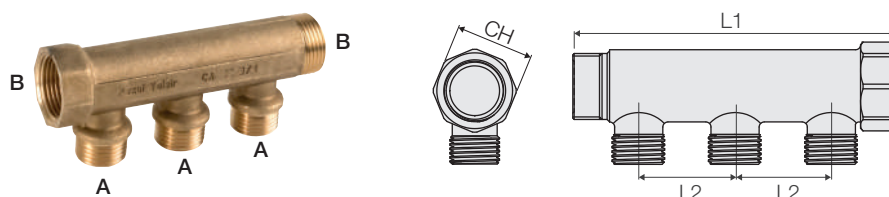

COD.	A (pol)	B (pol)	Saída	L1	L2	CH		QMM	€/un
PA11000132501	1/2"	3/4"	3	127	38	33	5	5	17.98 €
PA11000132513	3/4"	1"	3	127	38	33	5	5	26.85 €

Coletor 2 vias com válvula de corte

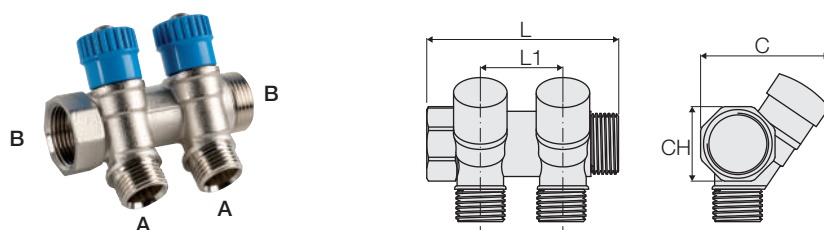

COD.	A (pol)	B (pol)	Saída	Cor manípulo	L	L1	C	CH		QMM	€/un
PA11000132601	1/2"	3/4"	2	azul	82,5	35,5	53	32	5	5	20.51 €
PA11000132605	1/2"	3/4"	2	vermelho	82,5	35,5	53	32	5	5	20.51 €

Coletor 3 vias com válvula de corte

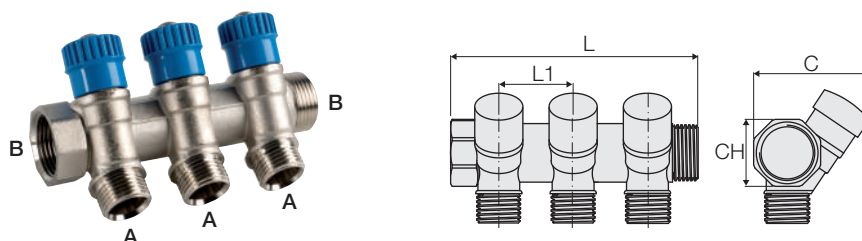

COD.	A (pol)	B (pol)	Saída	Cor manípulo	L	L1	C	CH		QMM	€/un
PA11000132701	1/2"	3/4"	3	azul	120	35,5	53	32	5	5	30.53 €
PA11000132705	1/2"	3/4"	3	vermelho	120	35,5	53	32	5	5	30.53 €

SISTEMA DISTRIBUIÇÃO

Coletor 3 vias com válvula de corte

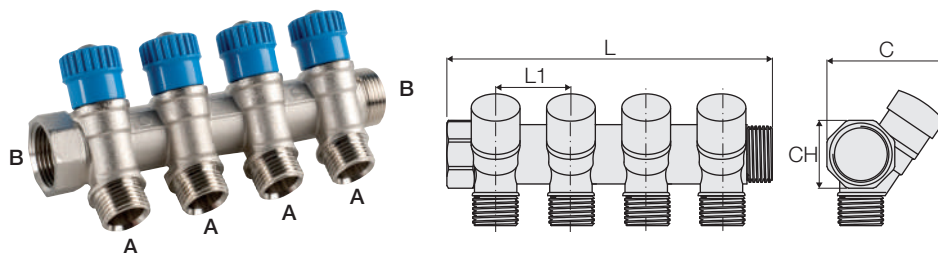

COD.	A (pol)	B (pol)	Saída	Cor manípulo	L	L1	C	CH		QMM	€/un
PA11000132771	1/2"	3/4"	4	azul	153,5	35,5	53	32	5	5	43.70 €
PA11000132775	1/2"	3/4"	4	vermelho	153,5	35,5	53	32	5	5	43.70 €

Válvula de corte

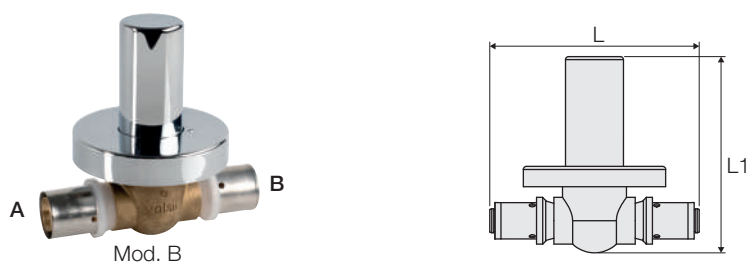

COD.	Mod.	A		B		L	L1		QMM	€/un
PA11000171406	B	16x2	H,TH,U	16x2	H,TH,U	103	97	5	5	44.84 €
PA11000171414	B	20x2	H,TH,U	20x2	H,TH,U	100	100	5	5	45.31 €

CONNEX-T
Colar de derivação
para sistema
multicamada

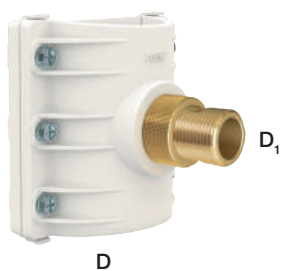

COD.	D tubo	D ₁		QMM	€/un
PC10000108151	50	1/2"M	5	5	61.85 €
PC10000108153	63	3/4"M	5	5	109.08 €
PC10000108155	75	3/4"M	2	2	167.88 €
PC10000108157	75	1"M	2	2	186.85 €
PC10000108159	90	1"M	2	2	340.50 €

Para a realização do furo é obrigatório utilizar a rosca COD 108111-108113-108115.

Rosca



COD.	D rosca	D tubo	D derivação		QMM	€/un
PC10000108111	1/2"	50	1/2"	1	1	49.75 €
PC10000108113	3/4"	63-75	3/4"	1	1	61.81 €
PC10000108115	1"	75-90	1"	1	1	83.46 €

Rosca para realizar o furo de derivação no tubo multicamada para o sistema Connex-T.



BRAVOPRESS®: acessórios de prensar em tecnopolímero.

BRAVOPRESS®, ACESSÓRIOS DE PRENSAR EM TECNOPOLÍMERO



Bravopress® é um sistema de acessórios de prensar realizados em PPSU, um tecnopolímero com características excepcionais de resistência mecânica e resistência à corrosão.

Bravopress® é compatível com os tubos Pexal® e Mixal® e pode ser utilizado para a realização de sistemas de abastecimento, aquecimento, arrefecimento e instalações industriais.



Matriz de prensagem H, U



Matriz de prensagem TH



Compatibilidade: uma ampla GAMA de ferramentas é possível prensar os acessórios com os vários perfis existentes no mercado (H, TH, U, C, VAL).



Resistência química: nos confrontos com as principais substâncias presentes na água (em particular cloro).



Performance: garantia de vedação graças à utilização de 2 o-rings.



Potabilidade: a utilização de matérias-primas adequadas garante a utilização para a distribuição de água potável.



Tecnologia: realizada em polisulfona (PPSU), um tecnopolímero com elevada resistência mecânica que garante prestações elevadas no tempo.



Sinalização de perda durante o ensaio da instalação em caso de falta de prensagem ou para prensagens realizadas entre os 0,5 e 2 bar.



Anel de prensagem já montado no acessório em aço inox AISI 304, com furos de inspeção.



Anel especial em PTFE para evitar as corrosões galvânicas entre o tubo e o acessório.



União

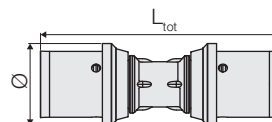

COD.	A	Ø _{OA}	B	Ø _{OB}	Ø	L _{tot}	Ø	QMM	€/un
PA13000152003	16x2	H,TH,U	16x2	H,TH,U	23	78	10	10	2.84 €
PA13000152009	20x2	H,TH,U	20x2	H,TH,U	27	78	10	10	3.32 €
PA13000152013	26x3	H,TH,C	26x3	H,TH,C	33	97	10	10	5.43 €
PA13000152015	32x3	H,TH,U	32x3	H,TH,U	39	105	5	5	7.50 €
PA13000150017	40x3,5	VAL,TH,U	40x3,5	VAL,TH,U	47	105	2	2	16.57 €
PA13000150020	50x4	VAL,TH,U	50x4	VAL,TH,U	57	106	2	2	24.62 €
PA13000150121	63x4,5	VAL,TH,U	63x4,5	VAL,TH,U	70	150	2	2	47.68 €

União redução

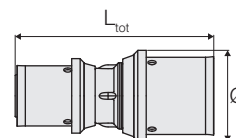

COD.	A	Ø _{OA}	B	Ø _{OB}	Ø	L _{tot}	Ø	QMM	€/un
PA13000152119	20x2	H,TH,U	16x2	H,TH,U	27	71	10	10	3.35 €
PA13000152127	26x3	H,TH,C	16x2	H,TH,U	33	78	10	10	4.90 €
PA13000152131	26x3	H,TH,C	20x2	H,TH,U	33	77	10	10	5.19 €
PA13000152143	32x3	H,TH,U	16x2	H,TH,U	39	82	5	5	7.15 €
PA13000152145	32x3	H,TH,U	20x2	H,TH,U	39	80	5	5	7.44 €
PA13000152149	32x3	H,TH,U	26x3	H,TH,C	39	87	5	5	7.98 €
PA13000150159	40x3,5	VAL,TH,U	26x3	H,TH,C	47	93	2	2	14.54 €
PA13000150161	40x3,5	VAL,TH,U	32x3	H,TH,U	47	93	2	2	15.87 €
PA13000150171	50x4	VAL,TH,U	32x3	H,TH,U	57	94	2	2	20.56 €
PA13000150173	50x4	VAL,TH,U	40x3,5	VAL,TH,U	57	103	2	2	22.04 €
PA13000150177	63x4,5	VAL,TH,U	40x3,5	VAL,TH,U	70	127	2	2	40.64 €
PA13000150179	63x4,5	VAL,TH,U	50x4	VAL,TH,U	70	129	2	2	42.59 €

União macho

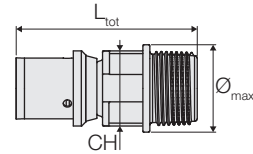

COD.	A	Ø _A	B (pol)	Ø _{max}	L _{tot}	CH		QMM	€/un
PA13000152205	16x2	H,TH,U	1/2"	25	63	22	10	10	2.88 €
PA13000152209	16x2	H,TH,U	3/4"	32	68	27	10	10	3.32 €
PA13000152213	16x2	H,TH,U	3/8"	20	58	18	10	10	2.95 €
PA13000152221	20x2	H,TH,U	1/2"	25	63	22	10	10	3.19 €
PA13000152225	20x2	H,TH,U	3/4"	32	65	27	10	10	3.60 €
PA13000152231	26x3	H,TH,C	1"	39	75	34	10	10	5.59 €
PA13000152233	26x3	H,TH,C	1/2"	25	68	22	10	10	4.57 €
PA13000152235	26x3	H,TH,C	3/4"	32	72	27	10	10	4.63 €
PA13000152239	32x3	H,TH,U	1"	39	76	34	5	5	6.86 €

União fêmea

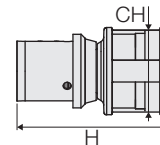

COD.	A	Ø _A	B (pol)	H	CH		QMM	€/un
PA13000152305	16x2	H,TH,U	1/2"	58	30	10	10	3.44 €
PA13000152309	16x2	H,TH,U	3/4"	58	37	10	10	4.36 €
PA13000152321	20x2	H,TH,U	1/2"	55	30	10	10	3.99 €
PA13000152325	20x2	H,TH,U	3/4"	56	37	10	10	4.97 €
PA13000152331	26x3	H,TH,C	1"	65	47	10	10	7.01 €
PA13000152335	26x3	H,TH,C	3/4"	63	37	10	10	5.06 €
PA13000152339	32x3	H,TH,U	1"	65	47	5	5	7.82 €

Joelho 45°

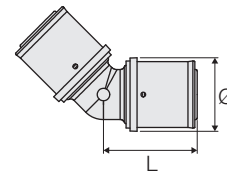

COD.	A	Ø _A	B	Ø _B	Ø	L		QMM	€/un
PA13000150467	40x3,5	VAL,TH,U	40x3,5	VAL,TH,U	47	60	2	2	23.22 €
PA13000150469	50x4	VAL,TH,U	50x4	VAL,TH,U	57	61	2	2	33.60 €
PA13000150471	63x4,5	VAL,TH,U	63x4,5	VAL,TH,U	70	89	2	2	56.81 €

Joelho 90°

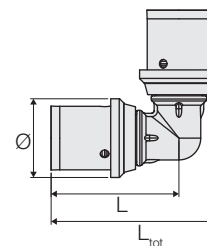

COD.	A	Ø _A	B	Ø _B	Ø	L _{tot}	L		QMM	€/un
PA13000152403	16x2	H,TH,U	16x2	H,TH,U	23	56	44	10	10	3.51 €
PA13000152409	20x2	H,TH,U	20x2	H,TH,U	27	58	44	10	10	4.23 €
PA13000152413	26x3	H,TH,C	26x3	H,TH,C	33	66	49	10	10	6.86 €
PA13000152415	32x3	H,TH,U	32x3	H,TH,U	39	77	57	5	5	9.17 €
PA13000150417	40x3,5	VAL,TH,U	40x3,5	VAL,TH,U	47	96	72	2	2	18.52 €
PA13000150419	50x4	VAL,TH,U	50x4	VAL,TH,U	57	110	81	2	2	28.53 €
PA13000150421	63x4,5	VAL,TH,U	63x4,5	VAL,TH,U	70	144	109	2	2	55.49 €

Joelho macho

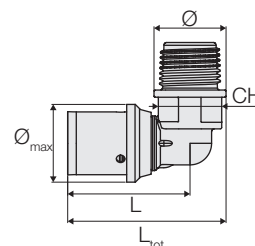

COD.	A	Ø _A	B (pol)	Ø	L _{tot}	L	Ø _{máx}	CH		QMM	€/un
PA13000152505	16x2	H,TH,U	1/2"	23	58	45	25	22	10	10	3.67 €
PA13000152521	20x2	H,TH,U	1/2"	27	56	43	25	22	10	10	4.47 €
PA13000152525	20x2	H,TH,U	3/4"	27	62	46	32	27	10	10	4.87 €
PA13000152531	26x3	H,TH,C	1"	33	77	57	39	34	10	10	7.37 €
PA13000152535	26x3	H,TH,C	3/4"	33	69	53	32	27	10	10	6.78 €
PA13000152539	32x3	H,TH,U	1"	39	77	57	39	34	5	5	9.98 €

Joelho fêmea

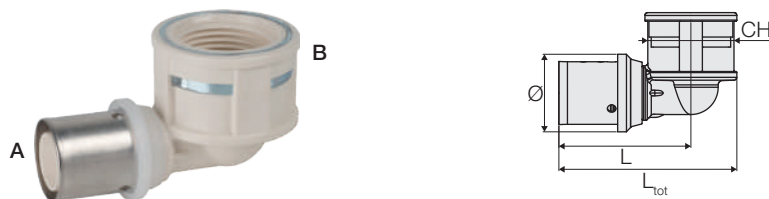

COD.	A	Ø _A	B (pol)	Ø	L	L _{tot}	CH		QMM	€/un
PA13000152605	16x2	H,TH,U	1/2"	23	48	65	30	10	10	3.81 €
PA13000152621	20x2	H,TH,U	1/2"	27	46	62	30	10	10	4.40 €
PA13000152625	20x2	H,TH,U	3/4"	27	50	69	37	10	10	5.11 €
PA13000152631	26x3	H,TH,C	1"	33	62	86	47	10	10	9.14 €
PA13000152635	26x3	H,TH,C	3/4"	33	57	77	37	10	10	6.46 €
PA13000152639	32x3	H,TH,U	1"	39	62	86	47	5	5	11.16 €

Tê

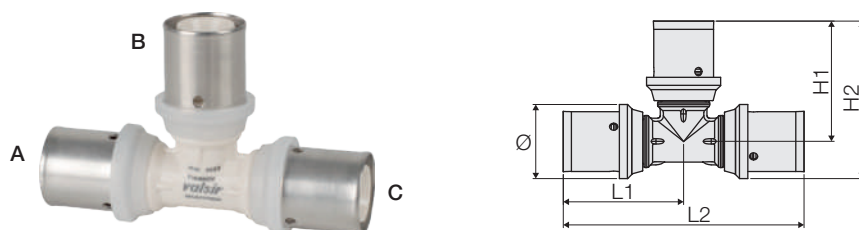

COD.	A	Ø _A	B	Ø _B	C	Ø _C	Ø	L1	L2	H1	H2		QMM	€/un
PA13000152703	16x2	H,TH,U	16x2	H,TH,U	16x2	H,TH,U	23	44	88	44	56	10	10	4.47 €
PA13000152709	20x2	H,TH,U	20x2	H,TH,U	20x2	H,TH,U	27	44	88	44	58	10	10	5.19 €
PA13000152713	26x3	H,TH,C	26x3	H,TH,C	26x3	H,TH,C	33	54	108	54	70	10	10	9.10 €
PA13000152715	32x3	H,TH,U	32x3	H,TH,U	32x3	H,TH,U	39	57	114	57	77	5	5	12.75 €
PA13000150717	40x3,5	VAL,TH,U	40x3,5	VAL,TH,U	40x3,5	VAL,TH,U	47	72	144	72	96	2	2	23.84 €
PA13000150719	50x4	VAL,TH,U	50x4	VAL,TH,U	50x4	VAL,TH,U	57	81	162	81	110	2	2	37.90 €
PA13000150721	63x4,5	VAL,TH,U	63x4,5	VAL,TH,U	63x4,5	VAL,TH,U	70	109	218	109	144	2	2	72.29 €

Tê redução

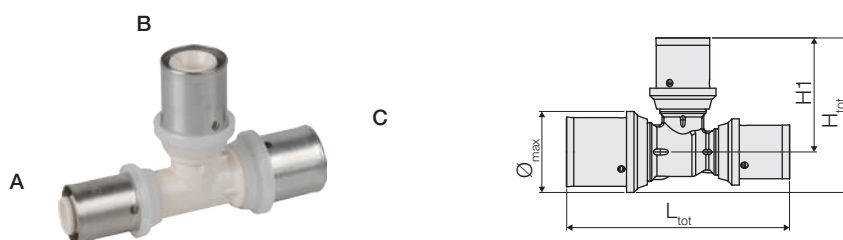

COD.	A	Ø _A	B	Ø _B	C	Ø _C	Ø _{máx}	L _{tot}	H1	H _{tot}		QMM	€/un
PA13000152807 *	16x2	H,TH,U	20x2	H,TH,U	16x2	H,TH,U	27	92	42	54	10	10	5.27 €
PA13000152815	20x2	H,TH,U	16x2	H,TH,U	16x2	H,TH,U	27	86	46	60	10	10	5.27 €
PA13000152819	20x2	H,TH,U	16x2	H,TH,U	20x2	H,TH,U	27	83	46	60	10	10	5.27 €
PA13000152825	20x2	H,TH,U	20x2	H,TH,U	16x2	H,TH,U	27	90	44	58	10	10	5.27 €
PA13000152829	20x2	H,TH,U	26x3	H,TH,C	20x2	H,TH,U	33	93	50	64	10	10	8.37 €
PA13000152833	26x3	H,TH,C	16x2	H,TH,U	26x3	H,TH,C	33	98	49	66	10	10	8.37 €

GAMA BRAVOPRESS

COD.	A	OA	B	OB	C	OC	Ø _{máx}	L _{tot}	H1	H _{tot}		QMM	€/un
PA13000152839	26x3	H,TH,C	20x2	H,TH,U	20x2	H,TH,U	33	95	47	64	10	10	8.37 €
PA13000152843	26x3	H,TH,C	20x2	H,TH,U	26x3	H,TH,C	33	101	47	64	10	10	8.37 €
PA13000152847	26x3	H,TH,C	26x3	H,TH,C	20x2	H,TH,U	33	97	54	71	10	10	8.37 €
PA13000152851	32x3	H,TH,U	16x2	H,TH,U	32x3	H,TH,U	39	100	52	72	5	5	10.69 €
PA13000152853	32x3	H,TH,U	20x2	H,TH,U	32x3	H,TH,U	39	104	50	70	5	5	11.56 €
PA13000152857	32x3	H,TH,U	26x3	H,TH,C	26x3	H,TH,C	39	108	52	72	5	5	11.56 €
PA13000152859	32x3	H,TH,U	26x3	H,TH,C	32x3	H,TH,U	39	108	52	72	5	5	11.96 €
PA13000152881	26x3	H,TH,C	16x2	H,TH,U	16x2	H,TH,U	33	95	49	66	10	10	7.37 €
PA13000152883	26x3	H,TH,C	26x3	H,TH,C	16x2	H,TH,U	33	100	54	71	10	10	8.37 €
PA13000152891	32x3	H,TH,U	32x3	H,TH,U	20x2	H,TH,U	39	104	57	77	5	5	11.56 €
PA13000152893	32x3	H,TH,U	32x3	H,TH,U	26x3	H,TH,C	39	111	57	77	5	5	11.96 €
PA13000150861	40x3,5	VAL,TH,U	20x2	H,TH,U	40x3,5	VAL,TH,U	47	126	58	82	2	2	21.18 €
PA13000150863	40x3,5	VAL,TH,U	26x3	H,TH,C	40x3,5	VAL,TH,U	47	132	65	89	2	2	21.18 €
PA13000150865	40x3,5	VAL,TH,U	32x3	H,TH,U	40x3,5	VAL,TH,U	47	138	63	87	2	2	22.51 €
PA13000150867	50x4	VAL,TH,U	26x3	H,TH,C	50x4	VAL,TH,U	57	138	70	99	2	2	31.26 €
PA13000150869	50x4	VAL,TH,U	32x3	H,TH,U	50x4	VAL,TH,U	57	144	68	97	2	2	32.04 €
PA13000150870	50x4	VAL,TH,U	40x3,5	VAL,TH,U	50x4	VAL,TH,U	57	152	77	106	2	2	34.39 €
PA13000150871	63x4,5	VAL,TH,U	32x3	H,TH,U	63x4,5	VAL,TH,U	70	188	74	109	2	2	61.42 €
PA13000150875	63x4,5	VAL,TH,U	40x3,5	VAL,TH,U	63x4,5	VAL,TH,U	70	196	84	119	2	2	62.13 €
PA13000150877	63x4,5	VAL,TH,U	50x4	VAL,TH,U	63x4,5	VAL,TH,U	70	206	88	123	2	2	68.78 €

Tê fêmea

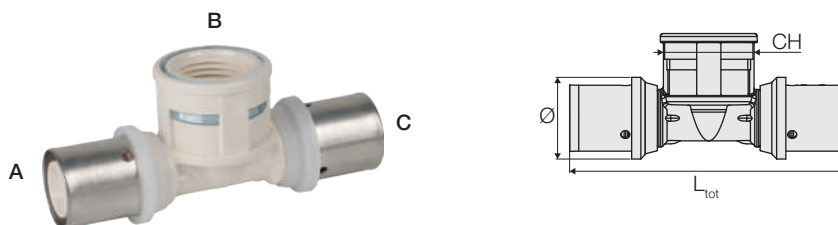

COD.	A	OA	B (pol)	C	OC	Ø	L _{tot}	CH		QMM	€/un
PA13000152905	16x2	H,TH,U	1/2"	16x2	H,TH,U	23	97	30	10	10	5.72 €
PA13000152921	20x2	H,TH,U	1/2"	20x2	H,TH,U	27	92	30	10	10	6.21 €
PA13000152925	20x2	H,TH,U	3/4"	20x2	H,TH,U	27	99	37	10	10	10.32 €
PA13000152935	26x3	H,TH,C	3/4"	26x3	H,TH,C	33	113	37	10	10	11.49 €
PA13000152937	32x3	H,TH,U	3/4"	32x3	H,TH,U	39	114	37	5	5	14.00 €
PA13000152939	32x3	H,TH,U	1"	32x3	H,TH,U	39	123	47	5	5	15.79 €

Joelho com flange

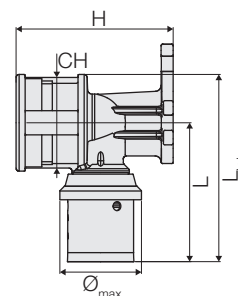
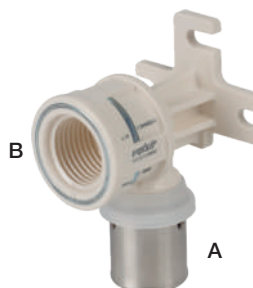

COD.	A	ØA	B (pol)	Ø _{máx}	L	L _{tot}	CH	H	QMM	€/un	
PA13000153005	16x2	H,TH,U	1/2"	23	48	65	30	52	10	10	4.48 €
PA13000153021	20x2	H,TH,U	1/2"	27	46	62	30	52	10	10	4.81 €
PA13000153025 *	20x2	H,TH,U	3/4"	27	50	69	37	56	10	10	5.53 €
PA13000153035 *	26x3	H,TH,C	3/4"	33	57	77	37	58	10	10	7.37 €

Tampão de proteção e ensaio instalação

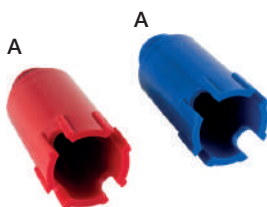

COD.	A (pol)	Cor	QMM	€/un
PC10000825051	G1/2" M	azul	10	1.58 €
PC10000825053	G1/2" M	vermelho	10	1.58 €
PC10000825056	G3/4" M	azul	10	1.73 €
PC10000825058	G3/4" M	vermelho	10	1.73 €

Placa de fixação para acessórios de flange



COD.	L	H	QMM	€/un
PC10000106018	210	45	10	3.48 €
PC10000106028	310	45	10	4.01 €



PEXAL[®] EASY: acessórios de caudal total em tecnopolímero

PEXAL® EASY, ACESSÓRIOS DE FLUXO TOTAL EM TECNOPOLÍMERO



Pexal® Easy é um sistema avançado de acessórios em tecnopolímero (PPSU) para a distribuição hídrica em sistemas de distribuição, aquecimento e arrefecimento, e a solução ideal para sistema de ar comprimido e instalações industriais em geral.

Utilizado em conjunto com o tubo Pexal®, garante um caudal de mais 30% face ao acessórios de prensar. Os acessórios são reutilizáveis e os tempos de instalação são reduzidos ao mínimo.



GAMA PEXAL EASY



Tecnologia: realizada em polisulfona (PPSU), um tecnopolímero com elevada resistência mecânica.



Possibilidade de reutilização dos acessórios.



Ausência total de fenômenos de oxidação e corrosão.



União mecânica “anti-risco” e sistema “antidesenroscamento”.



Passagem total do caudal e perdas de carga reduzidas graças ao sistema de ligação com o tubo.



união cônica “antideslizamento” com 2 o-rings de vedação.



Certificado para o transporte de água potável.



grande velocidade e extrema facilidade de instalação em obra.





O sistema elimina o problema da corrosão eletroquímica devido as correntes vagantes.

SISTEMA DISTRIBUIÇÃO



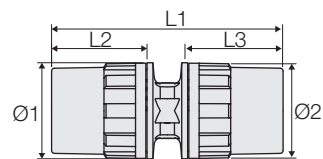

União

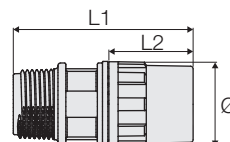

COD.	A	B	L1	Ø1	L2	Ø2	L3		QMM	€/un
PA12000160105	16x2	16x2	76	28	30	28	30	10	10	4.26 €
PA12000160109	20x2	20x2	82	33	32	33	32	10	10	4.96 €
PA12000160113	26x3	26x3	91	42	38	42	38	10	10	8.39 €
PA12000160117	32x3	32x3	97	50	40	50	40	5	5	11.48 €
PA12000160119	40x3,5	40x3,5	111	60	45	60	45	2	2	17.88 €
PA12000160121	50x4	50x4	141	73	58	73	58	2	2	27.64 €
PA12000160123	63x4,5	63x4,5	180	95	75	95	75	2	2	67.43 €
PA12000160125	75x5	75x5	206	115	80	115	80	1	1	87.68 €

União macho



COD.	A	B (pol)	Ø	L1	L2		QMM	€/un
PA12000160205	16x2	1/2"	28	64	30	10	10	2.91 €
PA12000160209	20x2	1/2"	33	66	32	10	10	3.46 €
PA12000160211	20x2	3/4"	32	66	32	10	10	4.42 €
PA12000160213	26x3	3/4"	42	75	38	10	10	6.39 €
PA12000160217	32x3	1"	50	80	40	5	5	8.13 €
PA12000160219	40x3,5	1"1/4	60	99	45	2	2	15.78 €
PA12000160221	50x4	1"1/2	73	0	58	2	2	23.41 €
PA12000160223	63x4,5	2"	95	138	75	2	2	42.46 €
PA12000160225	75x5	2"1/2	115	155	86	1	1	59.78 €

União fêmea

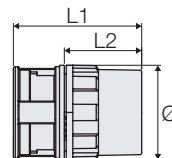

COD.	A	B (pol)	Ø	L1	L2		QMM	€/un
PA12000160305	16x2	1/2"	30	54	30	10	10	3.66 €
PA12000160309	20x2	1/2"	33	61	32	10	10	4.12 €
PA12000160311	20x2	3/4"	40	54	32	10	10	5.78 €
PA12000160313	26x3	3/4"	42	62	38	10	10	7.25 €
PA12000160317	32x3	1"	50	67	40	5	5	11.54 €
PA12000160319	40x3,5	1"1/4	60	79	45	2	2	20.13 €
PA12000160321	50x4	1"1/2	73	0	58	2	2	31.70 €
PA12000160323	63x4,5	2"	95	115	75	2	2	59.84 €

União redução

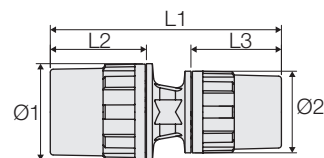

COD.	A	B	L1	Ø1	L2	Ø2	L3		QMM	€/un
PA12000160405	20x2	16x2	77	33	32	28	30	10	10	4.48 €
PA12000160409	26x3	20x2	86	42	38	33	32	10	10	6.23 €

Joelho 90°



COD.	A	B	L1	Ø1	L2	L3	Ø2	L4		QMM	€/un
PA12000160605	16x2	16x2	54	28	30	54	28	30	10	10	4.40 €
PA12000160609	20x2	20x2	56	33	32	56	33	32	10	10	5.72 €
PA12000160613	26x3	26x3	68	42	38	68	42	38	10	10	10.08 €
PA12000160617	32x3	32x3	77	50	40	77	50	40	5	5	13.28 €
PA12000160619	40x3,5	40x3,5	86	60	45	86	60	45	2	2	21.63 €
PA12000160621	50x4	50x4	104	73	58	104	73	58	2	2	35.04 €
PA12000160623	63x4,5	63x4,5	132	95	75	132	95	75	2	2	79.43 €
PA12000160625	75x5	75x5	155	115	86	155	115	86	1	1	103.62 €

Porca redução



COD.	A	B	Ø	L		QMM	€/un
PA12000160505	20x2	16x2	32,5	61	10	10	2.93 €
PA12000160509	26x3	16x2	41	62,5	10	10	4.19 €
PA12000160513	26x3	20x2	41	64	10	10	4.67 €
PA12000160517	32x3	16x2	50	65	5	5	5.02 €
PA12000160521	32x3	20x2	50	65	5	5	5.37 €
PA12000160525	32x3	26x3	50	69	5	5	6.56 €
PA12000160528	40x3,5	16x2	60	71,5	2	2	5.65 €
PA12000160530	40x3,5	20x2	60	80	2	2	6.08 €
PA12000160531	40x3,5	26x3	60	85	2	2	7.35 €
PA12000160533	40x3,5	32x3	60	88	2	2	8.84 €
PA12000160535	50x4	32x3	73	96,5	2	2	11.07 €
PA12000160537	50x4	40x3,5	73	100	2	2	13.36 €
PA12000160539	63x4,5	40x3,5	95	110	2	2	23.63 €
PA12000160541	63x4,5	50x4	95	117,5	2	2	28.34 €
PA12000160543	75x5	50x4	115	133,5	1	1	46.23 €
PA12000160545	75x5	63x4,5	115	143,5	1	1	58.20 €

Joelho 45°

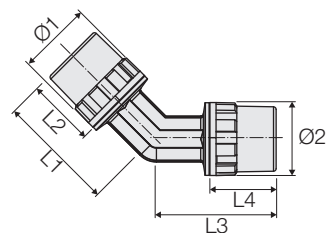

COD.	A	B	L1	Ø1	L2	L3	Ø2	L4		QMM	€/un
PA12000160639	20x2	20x2	46	33	32	46	33	32	10	10	5.23 €
PA12000160643	26x3	26x3	55	42	38	55	42	38	10	10	9.45 €
PA12000160647	32x3	32x3	59	50	40	59	50	40	5	5	12.81 €
PA12000160649	40x3,5	40x3,5	67	60	45	67	60	45	2	2	19.38 €
PA12000160651	50x4	50x4	83	73	58	83	73	58	2	2	32.76 €
PA12000160653	63x4,5	63x4,5	100	95	75	100	95	75	2	2	71.97 €
PA12000160655	75x5	75x5	122	115	86	122	115	86	1	1	96.46 €

Joelho macho

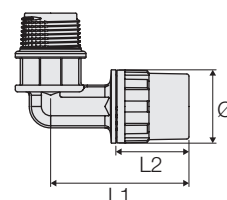

COD.	A	B (pol)	Ø	L1	L2		QMM	€/un
PA12000160705	16x2	1/2"	28	55	30	10	10	3.34 €
PA12000160709	20x2	1/2"	33	59	32	10	10	3.95 €
PA12000160711	20x2	3/4"	33	61	32	10	10	5.21 €
PA12000160713	26x3	3/4"	42	68	38	10	10	7.79 €
PA12000160717	32x3	1"	50	75	40	5	5	10.70 €

Joelho fêmea



COD.	A	B (pol)	Ø	L1	L2		QMM	€/un
PA12000160805	16x2	1/2"	28	53	30	10	10	4.14 €
PA12000160809	20x2	1/2"	33	59	32	10	10	4.73 €
PA12000160811	20x2	3/4"	33	61	32	10	10	6.60 €
PA12000160813	26x3	3/4"	42	68	38	10	10	8.65 €
PA12000160817	32x3	1"	50	75	40	5	5	13.55 €

Tê fêmea

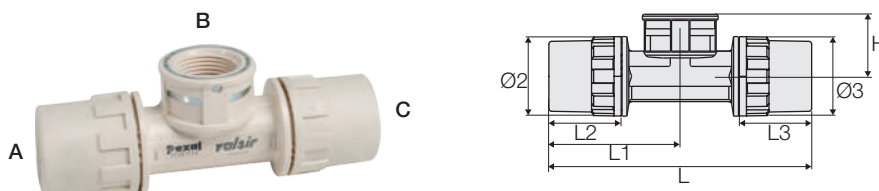

COD.	A	B (pol)	C	H	L	L1	L2	Ø2	L3	Ø3		QMM	€/un
PA12000161005	16x2	1/2"	16x2	31	108	54	30	28	30	28	10	10	6.59 €
PA12000161009	20x2	1/2"	20x2	31	120	60	32	33	32	33	10	10	7.20 €
PA12000161013	26x3	3/4"	26x3	32	136	68	38	42	38	42	10	10	12.43 €
PA12000161017	32x3	1"	32x3	38	150	75	40	50	40	50	5	5	19.39 €

Tê

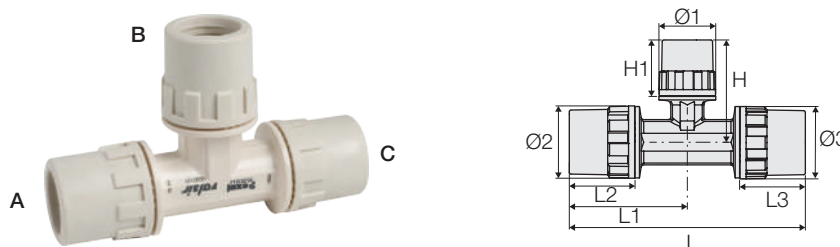

COD.	A	B	C	H	H1	Ø1	L	L1	L2	Ø2	L3	Ø3		QMM	€/un
PA12000160905	16x2	16x2	16x2	55	30	28	110	55	30	28	30	28	10	10	6.57 €
PA12000160909	20x2	20x2	20x2	58	32	33	115	58	32	33	32	33	10	10	8.42 €
PA12000160913	26x3	26x3	26x3	68	37	41	135	68	37	41	37	41	10	10	14.06 €
PA12000160917	32x3	32x3	32x3	75	40	50	150	75	40	50	40	50	5	5	19.38 €
PA12000160919	40x3,5	40x3,5	40x3,5	86	45	60	171	86	45	60	45	60	2	2	31.20 €
PA12000160921	50x4	50x4	50x4	91	58	73	182	91	58	73	58	73	2	2	50.73 €
PA12000160923	63x4,5	63x4,5	63x4,5	134	75	95	264	132	75	95	75	95	2	2	113.33 €
PA12000160925	75x5	75x5	75x5	155	87	115	310	155	87	115	87	115	1	1	143.48 €

SISTEMA DISTRIBUIÇÃO

Tê redução

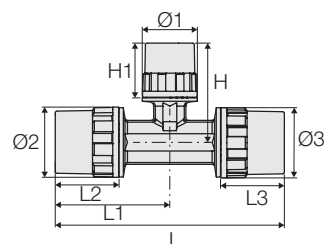
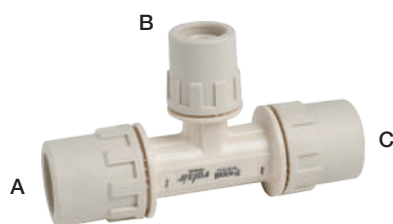

COD.	A	B	C	H	H1	Ø1	L	L1	L2	Ø2	L3	Ø3		QMM	€/un
PA12000161105	20x2	16x2	16x2	54	30	28	113	57	32	33	30	28	10	10	7.73 €
PA12000161103	20x2	16x2	20x2	54	30	28	117	59	32	33	32	33	10	10	8.00 €
PA12000161109	20x2	20x2	16x2	62	32	33	113	57	32	33	30	28	10	10	8.00 €
PA12000161113	26x3	16x2	26x3	54	30	28	136	68	38	42	38	42	10	10	11.69 €
PA12000161117	26x3	20x2	26x3	59	32	33	136	68	38	42	38	42	10	10	12.56 €
PA12000161119	32x3	16x2	32x3	62	30	28	150	75	40	50	40	50	5	5	15.85 €
PA12000161120	32x3	20x2	32x3	65	32	33	150	75	40	50	40	50	5	5	16.21 €
PA12000161121	32x3	26x3	32x3	68	38	42	150	75	40	50	40	50	5	5	16.68 €
PA12000161140	40x3,5	16x2	40x3,5	51	30	28	177	88,5	48	60	48	60	2	2	26.53 €
PA12000161141	40x3,5	20x2	40x3,5	52,5	32,5	32	177	88,5	48	60	48	60	2	2	26.53 €
PA12000161122	40x3,5	26x3	40x3,5	57,5	37,5	42	177	88,5	40	60	48	60	2	2	27.26 €
PA12000161123	40x3,5	32x3	40x3,5	75	40	50	172	86	45	60	45	60	2	2	28.15 €
PA12000161143	50x4	16x2	50x4	56	60	28	208	104	58	73	58	73	2	2	41.26 €
PA12000161144	50x4	20x2	50x4	57,5	32	33	208	104	58	73	58	73	2	2	41.26 €
PA12000161145	50x4	26x3	50x4	57,5	38	42	208	104	58	73	58	73	2	2	42.00 €
PA12000161124	50x4	32x3	50x4	57,5	40	50	208	104	58	73	58	73	2	2	42.73 €
PA12000161125	50x4	40x3,5	50x4	88,5	45	60	208	104	58	73	58	73	2	2	43.62 €
PA12000161146	63x4,5	16x2	63x4,5	63	30	28	263	131,5	75	95	75	95	2	2	85.46 €
PA12000161147	63x4,5	20x2	63x4,5	96,5	32	33	263	131,5	75	95	75	95	2	2	85.46 €
PA12000161148	63x4,5	26x3	63x4,5	102	38	42	263	131,5	75	95	75	95	2	2	86.93 €
PA12000161149	63x4,5	32x3	63x4,5	106,5	40	50	263	131,5	75	95	75	95	2	2	88.41 €
PA12000161126	63x4,5	40x3,5	63x4,5	112	45	60	263	131,5	75	95	75	95	2	2	89.88 €
PA12000161127	63x4,5	50x4	63x4,5	104	58	73	263	131,5	75	95	75	95	2	2	95.09 €
PA12000161129	75x5	63x4,5	75x5	132	75	95	297	148,5	80	115	80	115	1	1	133.91 €

Tê fêmea excêntrica

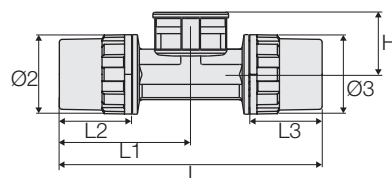
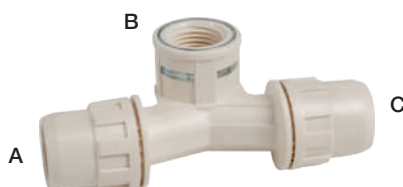

COD.	A	B (pol)	C	H	L	L1	L2	Ø2	L3	Ø3		QMM	€/un
PA12000161035	16x2	1/2"	16x2	31	110	55	30	28	30	28	10	10	6.54 €
PA12000161039	20x2	1/2"	20x2	31	118	59	32	33	32	33	10	10	7.28 €

Joelho com flange

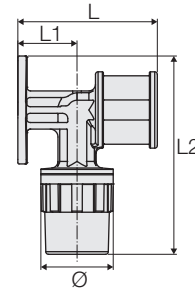
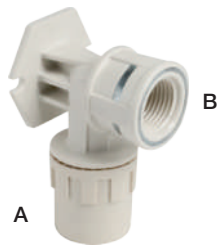

COD.	A	B (pol)	L	L1	L2	Ø		QMM	€/un
PA12000161205	16x2	1/2"	53	22,5	75,5	27,5	10	10	4.36 €
PA12000161209	20x2	1/2"	53	22,5	76	33	10	10	5.41 €

Placa de fixação para acessórios de flange

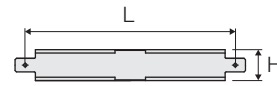

COD.	L	H		QMM	€/un
PC10000106018	210	45	10	10	3.48 €
PC10000106028	310	45	10	10	4.01 €

Tampão de proteção e ensaio instalação

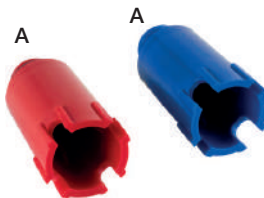

COD.	A (pol)	Cor		QMM	€/un
PC10000825051	G1/2" M	azul	10	10	1.58 €
PC10000825053	G1/2" M	vermelho	10	10	1.58 €
PC10000825056	G3/4" M	azul	10	10	1.73 €
PC10000825058	G3/4" M	vermelho	10	10	1.73 €

Válvula de corte

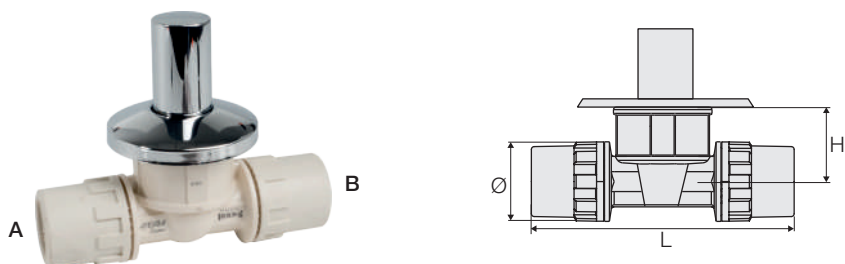

COD.	A	B	Ø	L	H		QMM	€/un
PA12000161305	16x2	16x2	28	108	31	10	10	17.98 €
PA12000161309	20x2	20x2	33	120	31	10	10	18.71 €
PA12000161313	26x3	26x3	42	136	32	10	10	27.52 €

Coletor modular



COD.	A	B	L1	L	H		QMM	€/un
PA12000161405	20x2	16x2	63,5	79	49,5	5	5	5.84 €
PA12000161407	26x3	16x2	74,5	90,5	59	5	5	7.93 €
PA12000161409	26x3	20x2	76,5	90,5	59	5	5	8.14 €

Coletor modular com válvula de fecho

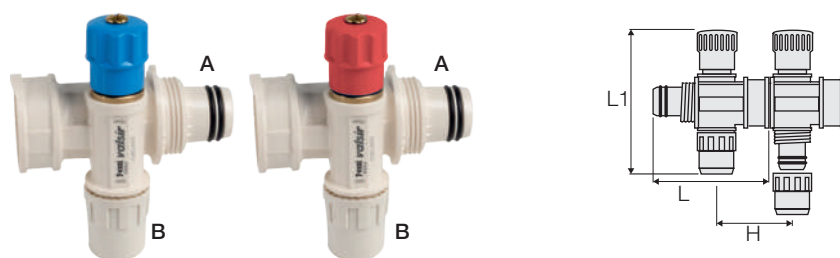

COD.	A	B	L	L1	H	Cor manipulo		QMM	€/un
PA12000161461	20x2	16x2	90	78,7	49,5	azul	5	5	9.80 €
PA12000161463	20x2	16x2	90	78,7	49,5	vermelho	5	5	9.80 €
PA12000161475	26x3	16x2	95	90,5	59	azul	5	5	10.67 €
PA12000161477	26x3	16x2	95	90,5	59	vermelho	5	5	10.67 €

Porca fecho

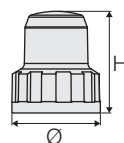

COD.	A	Ø	H		QMM	€/un
PA12000161605	16x2	27,5	31,5	10	10	1.29 €
PA12000161609	20x2	32,5	33	10	10	1.56 €
PA12000161613	26x3	41	35,5	10	10	2.54 €
PA12000161617	32x3	50	38,5	5	5	3.79 €
PA12000161619	40x3,5	60	43,5	2	2	4.68 €
PA12000161621	50x4	73	54	2	2	8.27 €
PA12000161623	63x4,5	81	73,5	2	2	19.36 €
PA12000161625	75x5	115	86,5	1	1	45.44 €

Tampão de fecho

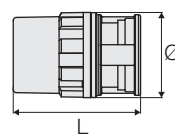

COD.	A	Ø	L		QMM	€/un
PA12000161505	16x2	28	43	10	10	2.40 €
PA12000161509	20x2	33	47	10	10	2.95 €
PA12000161513	26x3	42	62	10	10	5.43 €
PA12000161517	32x3	50	67	5	5	7.87 €
PA12000161519	40x3,5	60	72	2	2	12.56 €
PA12000161521	50x4	73	85	2	2	20.21 €
PA12000161523	63x4,5	95	110,5	2	2	42.68 €
PA12000161525	75x5	115	117,5	1	1	58.99 €

ACESSÓRIOS E FERRAMENTAS SISTEMA DE ABASTECIMENTO

Caixa metálica para coletor



COD.	Dimensões	Saídas coletor *			QMM	€/un
		Metal	PPSU			
PC10000104504	400x450x110	7	5	1	1	195.06 €
PC10000104506	600x450x110	11	9	1	1	253.12 €
PC10000104508	800x450x110	15	13	1	1	307.20 €
PC10000104510	1000x450x110	19	17	1	1	373.04 €

* Número máximo de saídas do coletor metálico ou PPSU baseado nas dimensões.
Na caixa não está incluído o suporte de fixação do coletor cod 102801.

Caixa plástica para coletor



COD.	Dimensões	Saídas coletor *			QMM	€/un
		Metal	PPSU			
PC10000104704	260x400x86	7	5	1	1	62.85 €
PC10000104705	260x500x86	9	7	1	1	69.58 €
PC10000104706	260x600x86	11	9	1	1	79.14 €

* Número máximo de saídas do coletor metálico ou PPSU baseado nas dimensões.

Colar de fixação



COD.	D	Ligação	Fixação		QMM	€/un
PC10000108016	16	M8	M8 x 100 mm	10	10	11.74 €
PC10000108020	20	M8	M8 x 100 mm	10	10	12.24 €
PC10000108026	26	M8	M8 x 100 mm	10	10	13.59 €
PC10000108032	32	M8	M8 x 100 mm	10	10	14.60 €
PC10000108040	40	M8	M8 x 100 mm	10	10	15.59 €
PC10000108050	50	M8	M8 x 100 mm	10	10	18.57 €
PC10000108063	63	M8/M10	M8 x 100 mm	10	10	19.69 €
PC10000108075	75	M8/M10	M8 x 100 mm	6	6	21.17 €
PC10000108090	90	M8/M10	M8 x 100 mm	6	6	22.81 €

Corta tubo



PEXAL - MIXAL

COD.	D		QMM	€/un
PC10000105000	14÷40	1	1	126.33 €
PC10000458011	6÷76	1	1	214.88 €
PC10000458003	50÷140	1	1	309.47 €

Corta tubo tesoura



PEXAL - MIXAL

COD.	D		QMM	€/un
PC10000105005	14÷26	1	1	368.93 €

Calibrador



PEXAL - MIXAL

COD.	D		QMM	€/un
PC10000105135	16x2-20x2-26x3	1	1	153.51 €

Calibro con impugnatura e fresa



PEXAL - MIXAL - THERMOLINE

COD.	D		QMM	€/un
PC10000105016	16x2	1	1	53.10 €
PC10000105018	20x2	1	1	53.82 €
PC10000105019	25x2,5	1	1	56.34 €
PC10000105020	32x3	1	1	60.12 €

SISTEMA
DISTRIBUIÇÃO

Calibrador com fresa de 9 mm



PEXAL

COD.	D		QMM	€/un
PC10000105138	40-50-63-75	1	1	278.39 €

Lubrificante



PEXAL - MIXAL

COD.	Peso (g)		QMM	€/un
PC10000105210	100	1	1	9.10 €

Mola curva tubos interna



PEXAL

COD.	D	L		QMM	€/un
PC10000116015	16	1000	1	1	21.04 €
PC10000116019	20	1000	1	1	22.31 €
PC10000116026	26	1000	1	1	29.07 €

Mola curva tubos externa



PEXAL - MIXAL

COD.	D	L		QMM	€/un
PC10000116116	16	260	1	1	15.52 €
PC10000116120	20	300	1	1	18.23 €

Prensadora EVO com matrizes D 16-20-26



PEXAL BRASS - BRAVOPRESS

COD.	Força (kN)	HxLxP (mm)	Bateria	kg		QMM	€/un
PC10000133899	32	300x280x86	Li-ion 18 V-2Ah	2,9	1	1	3 891.48 €

A prensadora é fornecida completa de mala, uma bateria de lítio de 18V e 2Ah, carregador e cabo de ligação ao PC para dados de utilização. Estão incluídas as matrizes de 16, 20, 26 mm perfil H.

Matriz para prensadora Valsir Máxipress



PEXAL BRASS - BRAVOPRESS

COD.	D			QMM	€/un
PC10000133816	16	H	1	1	426.18 €
PC10000133820	20	H	1	1	462.51 €
PC10000133926	26	H	1	1	492.46 €
PC10000133932	32	H	1	1	518.86 €
PC10000133940	40	U	1	1	667.85 €

Insero para matriz de prensar Valsir Máxipress

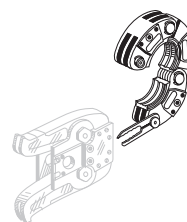

PEXAL BRASS - BRAVOPRESS



COD.	D			QMM	€/un
PC10000133909	50	U	1	1	2 136.91 €
PC10000133910	75	U	1	1	3 522.19 €
PC10000133911	63	U	1	1	3 495.68 €
PC10000133961	90	U	1	1	3 757.50 €

SISTEMA DISTRIBUIÇÃO

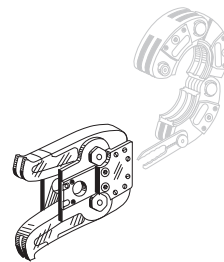
**Matriz para
prensadora Valsir
Máxipress**



PEXAL BRASS - BRAVOPRESS

COD.	D			QMM	€/un
PC10000133905	40-50-63	U	1	1	897.45 €
PC10000133962	75-90	U	1	1	1 049.36 €

As matrizes podem ser usadas apenas após a inserção dos inserts na prensadora.

**Prensadora manual
com matrizes**



PEXAL BRASS - BRAVOPRESS

COD.		QMM	€/un
PC10000133890	1	1	1 173.19 €

Estão incluídos os inserts D16, 20, 26 e 32 mm.

Chave para aperto



PEXAL EASY

COD.	D	Mat.		QMM	€/un
PC10000162303	16-20	plastica	1	1	2.20 €
PC10000162305	26-32	plastica	1	1	3.51 €
PC10000162308	40	alluminio	1	1	92.55 €
PC10000162309	50	alluminio	1	1	126.19 €
PC10000162311	63	alluminio	1	1	165.71 €
PC10000162313	75x5	alluminio	1	1	169.16 €

Expansora manual



PEXAL EASY

COD.	D Extratores		QMM	€/un
PC10000162201	16-20x2-20x2,5-26-32	1	1	790.73 €

A expansora é fornecida completa de extratores.

**Expansora a bateria
BE32 18 V**



PEXAL EASY

COD.	Bateria	D Extratores		QMM	€/un
PC10000162215	Ni-cd - 18 V	16x2 - 20x2 - 20x2,5 - 26x3 - 32x3	1	1	2 066.65 €

A expansora é fornecida com uma mala, bateria, carregador e os extratores.

**Expansora a bateria
BE90 18 V**



PEXAL EASY

COD.	D Extratores	Bateria		QMM	€/un
PC10000162224	40-50-63	Li-ion 18 V-3Ah	1	1	5 523.89 €

A expansora é fornecida com uma mala, bateria, carregador e os extratores.

Expansor mecânico



PEXAL EASY

COD.	D		QMM	€/un
PC10000162152	40	1	1	666.40 €
PC10000162154	50	1	1	681.11 €
PC10000162156	63	1	1	689.86 €
PC10000162157	75x5	1	1	860.88 €

Para expansora BE90 18 V.

As Condições Gerais de Venda em vigor, regulam todas as transações comerciais entre a OLI Sistemas Sanitários, S.A. e o cliente, aplicando-se a todas as encomendas, entregas, pagamentos, devoluções e garantias respeitantes a bens, equipamentos, materiais e serviços prestados pela OLI Sistemas Sanitários, S.A.. O documento detalhado encontra-se disponível para consulta no site oficial da OLI Sistemas Sanitários, S.A.

www.oli-world.com/pt/condicoes-gerais-de-venda

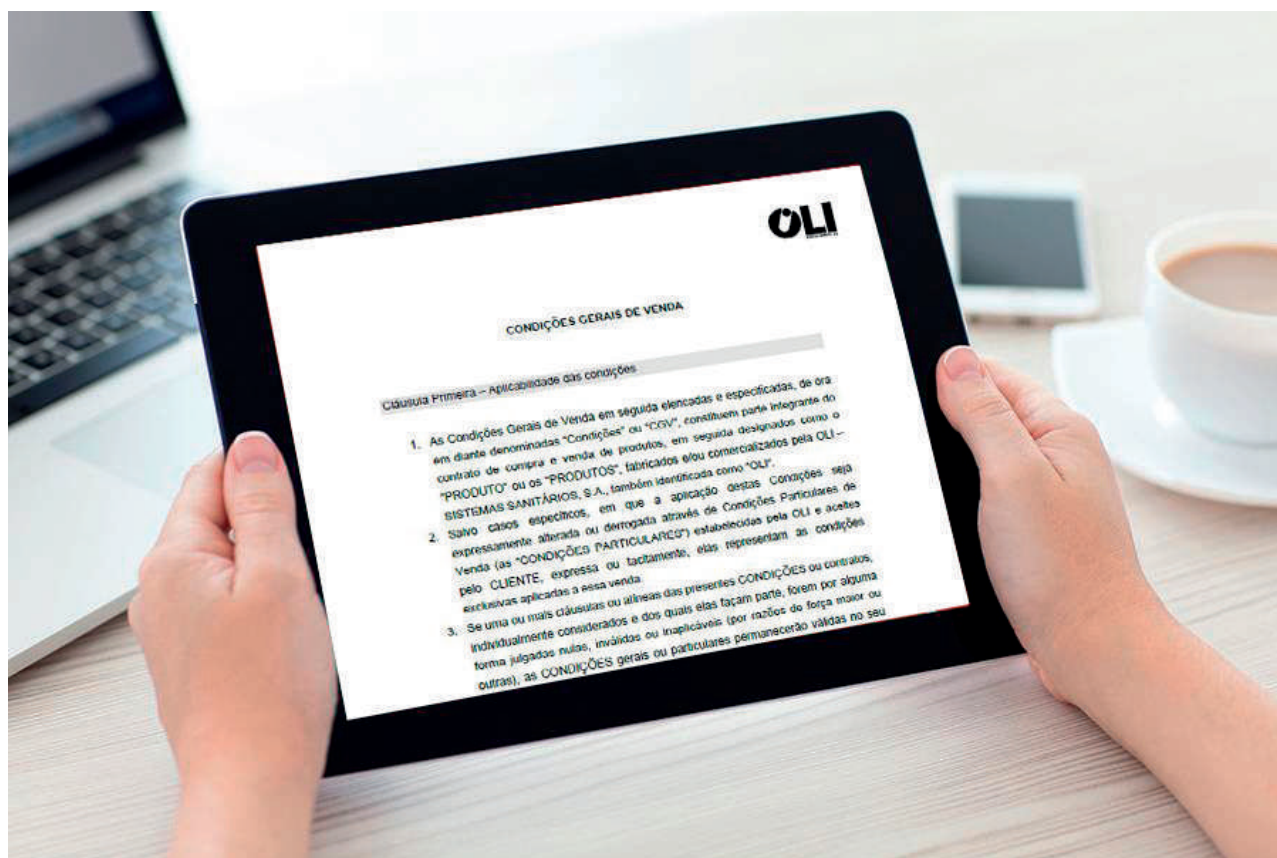

A OLI – Sistemas Sanitários, S.A. reserva-se o direito de proceder a alterações nos produtos deste catálogo sem aviso prévio. As informações e especificações deste catálogo são válidas, salvo erros tipográficos. As imagens de produto são apenas ilustrativas. Os preços indicados não incluem IVA. Este catálogo anula os anteriores.

SERVIÇOS OLI

SERVIÇO DE APOIO A CLIENTE

Sempre em contacto através de telefone e e-mail

A OLI coloca à disposição o número de telefone +351 234 300 200, e e-mail comercial@oli-world.com que proporcionam um serviço de linha direta.



BIM

OLI DISPONIBILIZA BIBLIOTECA BIM E REFORÇA O COMPROMISSO COM A INOVAÇÃO CONTÍNUA

Com a metodologia BIM, a OLI tem como objetivo potenciar a eficiência e a criatividade dos projetos de construção, através de um trabalho cooperativo com arquitetos, engenheiros, empreiteiros e proprietários.



COLORADD

OLI pioneira a adotar o código universal de cores

A OLI é a primeira empresa de sistemas sanitários do mundo a adotar o Color ADD, um código único, universal e transversal, que permite às pessoas daltónicas identificarem corretamente as cores.



Branco



Preto Preto Soft Touch



Mate Escovado



Antracite Cinza Soft Touch



Red



Taupe



Gold



Cromado

OLI NAS REDES SOCIAIS

Siga todas as novidades



OLI TECH

A OLI TECH foi desenvolvida para fornecer acesso direto a informações úteis a profissionais.

Garantia de rápido acesso a fichas técnicas, instruções de montagem, vídeos e características principais de produtos que a OLI disponibiliza no mercado.

Descarrega a OLI TECH e dá à OLI feedback para o e-mail: communication@oli-world.com

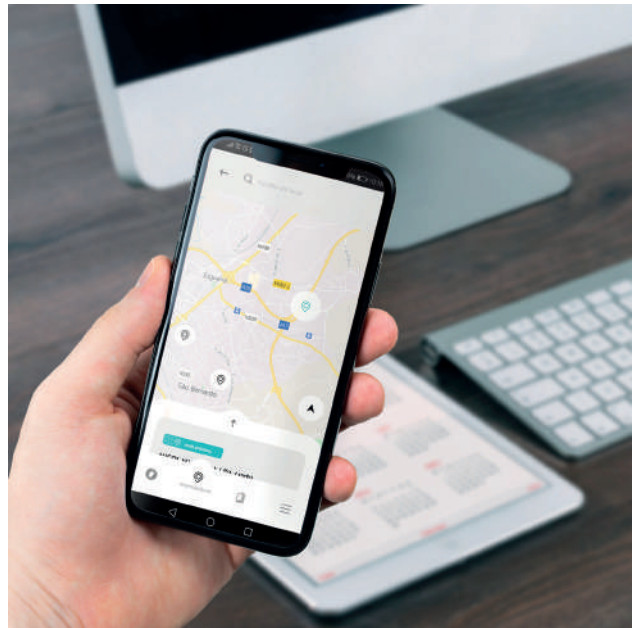
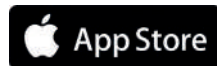

FAVORITOS



DISTRIBUIDORES



PEÇAS DE SUBSTITUIÇÃO



FEEDBACK



NOVOS PRODUTOS



www.oli-world.com/pt/servicos/showroom-360-/

SHOWROOM 360°

Várias soluções de autoclismos sustentáveis, placas de comando de dupla descarga e mecanismos para todo o tipo de paredes e sanitas.

Navegue e descubra todas as soluções inovadoras e sustentáveis que disponibilizamos numa configuração que o aproxima da instalação real.

Descubra novos produtos e encontre todas as informações necessárias de maneira intuitiva!

T.0074.11 - 02.2023
ZB03000000051

valsir[®]
QUALITY FOR PLUMBING

DISTRIBUTED BY

OLI

M | **OLI- Sistemas Sanitários, S.A.**
Travessa do milão,
Esgueira
3800 - 314 Aveiro, Portugal

T | (+351) 234 300 200
F | (+351) 234 300 220
Chamada rede fixa nacional

W | www.oli-world.com
E | estudos@oli-world.com