

### SANITARBLOCK

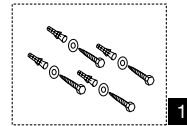

### SIMFLEX

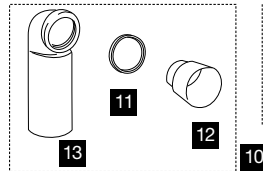
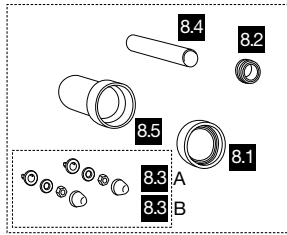
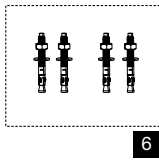
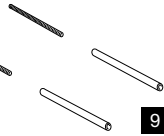
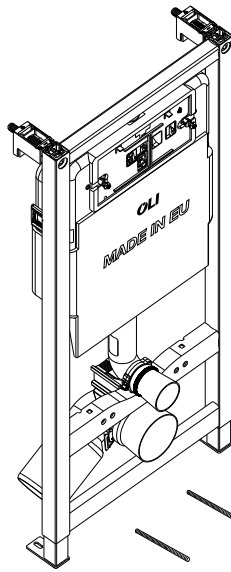
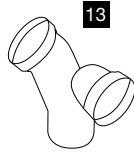
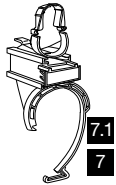
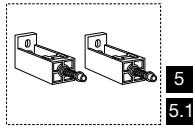
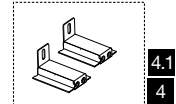
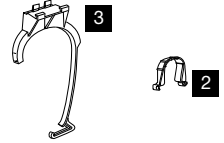

Nr.	Cod.	Descrizione	Qt. Cod.	€
1	OL0037148	KIT VITI TASSELLI FISSAGGIO STRUTTURA Ø 10 (4 PZ)	4	4,05
2	OL0037145	COLLARE PORTA-CURVA SIMFLEX Ø 45	1	5,00
3	OL0011984	COLLARE PORTA-CURVA SIMFLEX Ø 90	1	5,05
4	OL0034898	KIT FISSAGGI BARRE FILETTATE SIMFLEX 80 MM	2	10,95
5	OL0054389	KIT FISSAGGI FAST-FIT 144 MM	2	24,65
5.1	OL0004252	KIT FISSAGGI FAST-FIT 181 MM	1	24,65
6	OL0012196	KIT FISSAGGI STRUTTURA AUTOPORTANTE	4	15,35
7	OL0048974	PORTA CURVA SANITARBLOCK Ø 90	1	6,30
7.1	OL0195524	PORTA CURVA SANITARBLOCK S80 Ø 90	1	6,50
8	OL0037137	KIT MANICOTTI WC SOSPESO Ø 45 Ø 90	1	15,20
8.1	OL0037134	GUARNIZIONI PER MANICOTTO WC Ø 125	1	3,00
8.2	OL0622803	MORSETTO Ø 45	5	1,65
8.3 A	OL0622301	KIT COPPELLE BIANCO	2	5,20
8.3 B	OL0622303	KIT COPPELLE CROMO LUCIDO	2	7,00
8.4	OL0037132	CANNOTTO Ø 45 L. 180	1	3,40
8.5	OL0037129	MANICOTTO Ø 90 PP L. 250	1	6,55
9	OL0036886	KIT BARRE FILETTATE M 12	2	8,80
10	OL0036888	CURVA WC Ø 90 PP L. 340	1	15,60
10.1	OL0053995	CURVA WC Ø 90/110 PP L. 300	1	17,05
11	OL0036889	GUARNIZIONE 1 LABBRO Ø 90	5	3,50
12	OL0036890	TAPPO CURVA WC X VASO SOSPESO Ø 90	1	1,00
13	OL0622017	CURVA DI SCARICO Ø 90/110 PE DOPPIA	1	52,90

# STRUTTURE

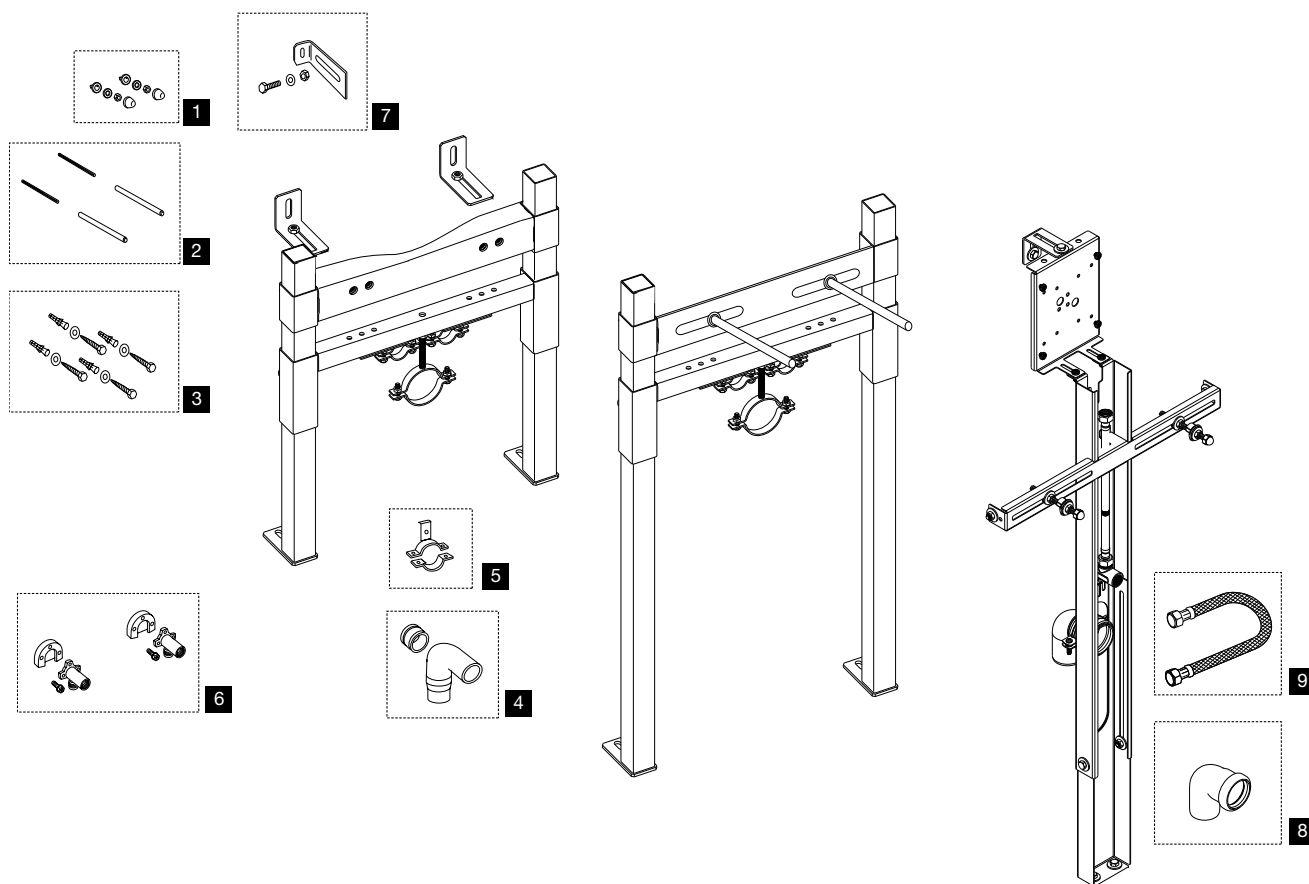

Nr.	Cod.	Descrizione	Qt. Cod.	€
1.1	OL0622301	KIT COPPELLE BIANCO	2	5,20
1.2	OL0622303	KIT COPPELLE CROMO LUCIDO	2	7,00
2	OL0036886	KIT BARRE FILETTATE M 12	2	8,80
3	OL0037148	KIT VITI TASSELLI FISSAGGIO STRUTTURA Ø 10 (4 PZ)	4	4,05
4	OL0054576	CURVA PP Ø 50	1	12,35
5	OL0037144	SUPPORTI METALLICI BIDET SIMFLEX	1	11,70
6	OL0011170	RACCORDI OTTONE SIMFLEX	2	21,15
7	OL0054577	KIT FISSAGGI SQUADRETTE L. 120	2	19,15
8	OL0878901	CURVA DI SCARICO Ø 50/50 ECO URINAL	1	12,35
9	OL0878900	FLESSIBILE ½"x½" L. 300	1	20,00

